



# INSTALLATION & OPERATION MANUAL



## EVO270-1

HOT WATER HEAT PUMP



## Contents

1. Introduction.....	2
2. Dimensions.....	2
3. Quick Start Guide .....	3
4. Safety Instructions .....	4
5. Installation .....	5
5.1 System Installation .....	5
5.2 Handling & Transportation .....	6
5.3 Location of Installation .....	6
5.3.1 Indoor Installation .....	6
5.4 Airflow Clearances .....	7
5.5 Cable Connection.....	7
5.6 Filling the Tank.....	7
5.7 Initial Start-Up .....	7
6. Operation.....	8
6.1 The Controller .....	8
6.2 Operating Functions.....	9
6.2.1 Locking the Controller .....	9
6.2.2 Startup & Shutdown.....	9
6.2.3 Switching Modes .....	9
6.2.4 Setting & Checking the Target Temperature .....	10
6.2.5 Hydroboost Setting .....	10
6.2.6 Force Defrost.....	10
6.2.7 System Date & Time.....	11
6.2.8 Setting & Cancelling Timers.....	11
6.2.9 Vacation Mode.....	12
6.2.10 Sanitech System.....	13
6.2.11 Fan/Ventilation Function .....	13
7. Troubleshooting.....	14
8. Appendix .....	15
8.1 Wiring Diagram .....	15
8.2 Wi-Fi Module Connection (Optional).....	16
8.3 Use of the P&T Valve .....	16
8.4 Using the Overheating Protector .....	16
8.5 Draining the Water Tank .....	17
9. Maintenance.....	18
10. Warranty.....	19

## 1. Introduction

This manual contains information relating to the installation, troubleshooting, operation, and maintenance of this EvoHeat unit. Instructions in this manual must always be followed. Failure to comply with these recommendations will invalidate the warranty. Should you have any questions or require technical support, call the EvoHeat office on 1300 859 933 to speak to our team.

TECHNICAL DATA		Evo270-1
Storage Capacity	<b>L</b>	270
Max Temperature Setting	<b>°C</b>	60
Power Input	<b>kW</b>	0.94
Heating Output	<b>kW</b>	3.6
<b>C.O.P at 20°C Air</b>		<b>4.27</b>
Noise Rating	<b>dB(A)</b>	48
Running Current	<b>A</b>	3.9
Power Supply		220-240V/1/50Hz
Refrigerant	<b>g</b>	R134a / 1900g
Water Inlet/Outlet Size	<b>mm</b>	20 (3/4")
Auxiliary Heating	<b>kW</b>	1.5
Operating Temperature Range	<b>°C</b>	-5 to 43
Hot Water Recovery	<b>L/hr</b>	89
With Hydro Boost	<b>L/hr</b>	119
Net Weight	<b>kg</b>	130



The EVO 270-1 is the next evolution in water heating with advanced energy efficiency technologies and built-in smart features to ensure you're provided with clean, safe, and economical hot water all year round.

Conforms to AS 3498-2020 Australia and New Zealand

Measurement conditions: Instant heating: Ambient air temperature 20°C/15°C, water inlet 15°C, water outlet 55°C, highest setting temperature: 75°C

Working Temp Range

1. Ambient temperature is -5°C ~ 43°C (Heat Pump)
2. The max temperature of water tank is 70

Operating parameters: The range of the operating water pressures: 0.15~0.7MPa

## 2. Dimensions

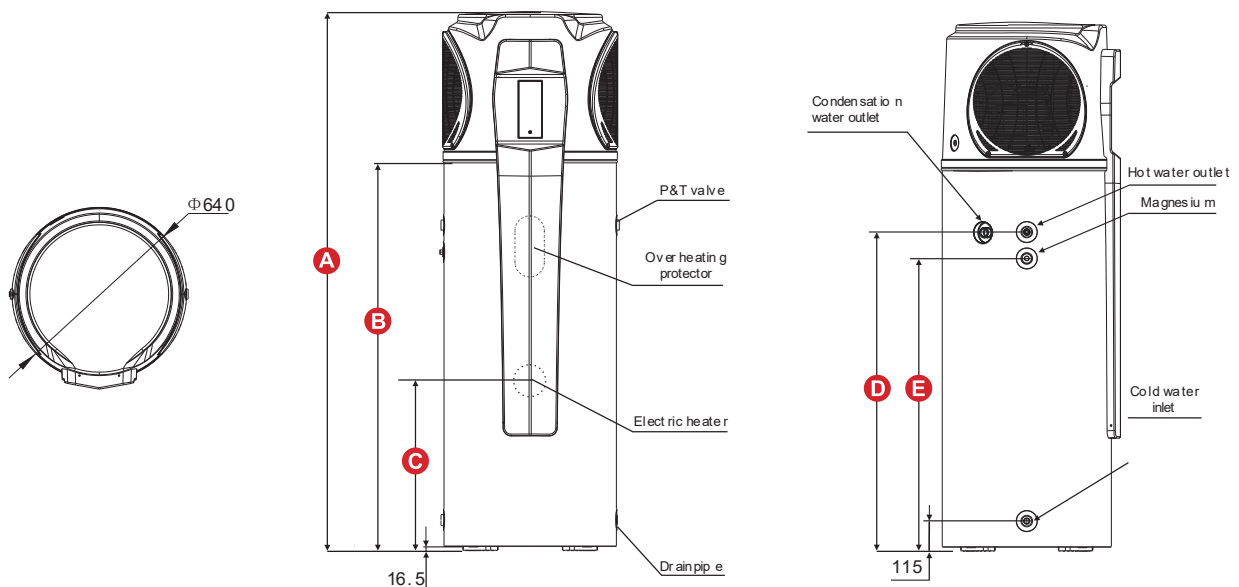

Evo270-1 (unit: mm)	A	B	C	D	E	DIAMETER
	1992	1443	593	1211	1111	640



# QUICK START GUIDE













## Evo270-1



### DO NOT DRILL

Do not drill any fixings or attachments into the outer casing of the tank. Drilling into the outer casing of the tank may damage the heating coil and WILL VOID WARRANTY.

### INITIAL STARTUP

1. Press and hold  for one second to power on the unit.
2. To set the time:
  - a. Press  once so the hour digit starts flashing,
  - b. Use   to adjust the hour and press  to confirm,
  - c. Repeat for the minute, day, month and year,
  - d. Press  at any stage to cancel.
3. Press  until  is displayed. This will activate “Eco Heating” (Heat Pump only) mode and will provide the most efficient heating.
4. During periods of unusually high hot water demand (such as additional occupants staying with you), you can activate “High Requirement” mode by pressing  until  is displayed.
5. In any event where there is a failure within the system, the Electric Element (Hydroboost Mode) can be engaged with “one push activation” of the  button until  is displayed. This will provide emergency water heating until service can be attended.
6. For adjustment of timers or activating vacation mode, please refer to our online tutorials at:  
[www.evoheat.com.au/tech-support](http://www.evoheat.com.au/tech-support)

## 4. Safety Instructions



Ensure that all safety instructions and recommendations are always adhered to. Failure to comply with these recommendations could void the warranty and cause injury or death.

- Installation, repair, or relocations must only be done by a fully qualified technician.
- The Evo270-1 must be installed to conform to all relevant Australian Standards and Industry Codes including but not limited to: Electrical & Electrical Safety, Plumbing & Hot Water Storage, Heat Pump Installation & Operation
- A circuit breaker must be installed for the unit.
- Ensure the unit has a good power connection and earthing to avoid the risk of electrical shocks.
- Ensure that there are no leaks on both the plumbing and drainage fittings.
- The unit must not be installed near flammable gas or have flammable aerosols sprayed in the vicinity.
- The base that the unit is installed on must be level and stable.
- If the supply cord is damaged, it must be replaced by a qualified service agent.
- This appliance must be installed in accordance with national wiring regulations.
- Installation must also comply with any local, state or federal codes at the installation site. Failure to comply can void your warranty, damage your unit or possibly cause injury or death. Plumbing must comply with AS/NZS3500.4
- Before obtaining access to terminals all supply circuits must be disconnected.
- A P&T valve **MUST** be installed in the tank. When the tank pressure reaches 0.85MPa or when the tank temperature reaches 99°C, the P&T valve will open automatically so as to reduce the pressure or temperature decrease.
- In the event of the unit malfunctioning, shut off the power supply and contact your supplier or EvoHeat.
- In order to use the unit correctly, run the unit at environment temperature -5°C - 43°C
- The unit contains sophisticated electronic devices, do not use unsafe water sources such as lake or groundwater.
- The unit produces hot water and will also have hot fittings, therefore should not be touched to avoid injury.
- Do not drill any fixings or attachments into the outer casing of the tank. Drilling into the outer casing of the tank may damage the heating coil and **WILL VOID WARRANTY.**
- If the unit stops and you restart the unit or turn it on manually, the unit will not start to run again for approximately 3 minutes. This is a protection feature to safeguard the compressor.
- The handle of the P&T safety valve should be tested once every six months to remove the calcium carbonate deposits and guarantee there is no blockage in the device.
- Once installation is complete, check that all connections are secure before the power is turned on.
- The installer is to explain to the end user how to operate and maintain the unit in accordance with this instruction manual.
- Evo Industries Australia Pty Ltd will not be held responsible for any damages or injuries caused by the incorrect installation of this hot water system.
- A maintenance programme must be carried out as recommended in this manual to ensure ongoing reliability.

To reduce the risk of excessive pressures and temperatures in this water heater, install temperature and pressure protective equipment required by local codes and no less than a combination temperature and pressure relief valve certified by a nationally recognized testing laboratory that maintains periodic inspection of production of listed equipment or materials, as meeting the requirements for Relief Valves and Automatic Gas Shutoff Devices for Hot Water Supply Systems, ANSIZ21.22. This valve must be marked with a maximum set pressure not to exceed the marked maximum working pressure of the water heater. Install the valve into an opening provided and marked for this purpose in the water heater, and orient it or provide tubing so that any discharge from the valve exits only within 6 inches above, or at any distance below, the structural floor, and does not contact any live electrical part. The discharge opening must not be blocked or reduced in size under any circumstances.

Hydrogen gas is produced in a hot water system served by this heater that has not been used for a long period of time (2 weeks or more). Hydrogen gas is extremely flammable. To reduce the risk of injury under these conditions, it is recommended that the hot water faucet be opened for several minutes at the kitchen sink before using any electrical appliance.

The appliance is fitted with means for disconnection from the supply mains having a contact separation in all poles that provide full disconnection under overvoltage category III conditions, and these means must be incorporated in the fixed wiring in accordance with the wiring rules.



Always use a suitably qualified Electrician to perform any electrical work, they must read the manual before connecting.

Ensure all cabling, circuit breakers, and protections are of a suitable size and specification in accordance with electrical wiring legislation for the heater being installed. Ensure to check that there is adequate voltage and current available at the heater connection to run the unit.



### WARNING

#### THIS PRODUCT CONTAINS A BUTTON BATTERY

If swallowed, a lithium button battery can cause severe or fatal injuries within 2 hours.

Keep batteries out of reach of children.

If you think batteries may have been swallowed or placed inside any part of the body, seek immediate medical attention.

## 5. Installation

### 5.1 System Installation

Upon receiving the unit, check the packaging for any obvious signs of damage. Inform EvoHeat immediately if there is any evidence of rough handling.



Do not drill any fixings or attachments into the outer casing of the tank. Drilling into the outer casing of the tank may damage the heating coil and **WILL VOID WARRANTY**.



The P&T valve attached with the unit must be installed. Failure to do so will cause damage to the unit and possible personal injury.



Drain the water tank through the drain valve at the bottom part of the unit.



Do not use stainless steel fittings to connect directly with other metals to prevent galvanic corrosion.

**Note:** A pressure releasing valve is to be fitted within the installation. Spec of P&T valve: Pressure: 0.85MP Temperature: 99°C

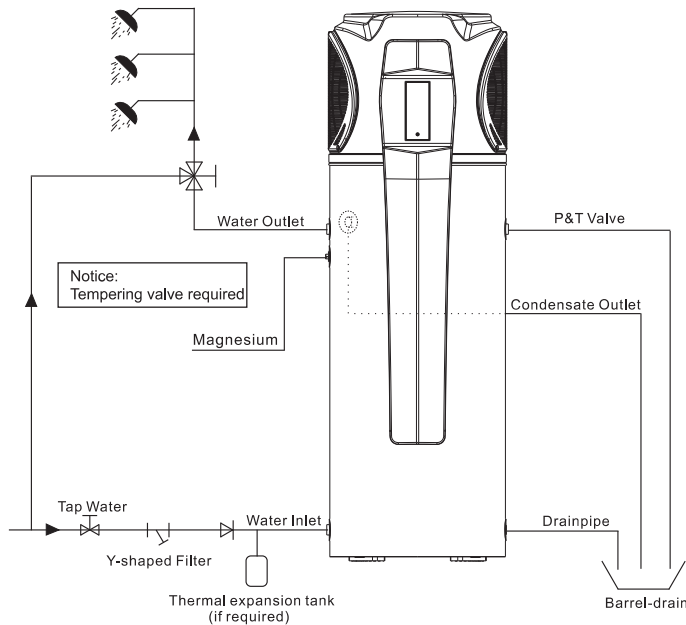

**Water Inlet or Outlet Pipes:** The specification of the water inlet and outlet thread is BSP3/4 (internal thread). Pipes must be heat-resistant and durable.

**Piping for the P&T Valve:** The spec of the valve connecting thread is BSP3/4 (internal thread). After installation, confirm that the drainpipe outlet is exposed in the air. When the flexible drainpipe is joined to the pressure relief orifice of this valve, ensure that the flexible drainpipe is pointing downwards and exposed in the air.



## 5.2 Handing & Transportation

The unit should be stored and/or transported in an upright position and without water charge. For transport over short distances, and provided due care is exercised, an inclination angle of up to 30 degrees is permitted. During transport and storage, ambient temperatures of -10 to +60 degrees Celsius are permissible.

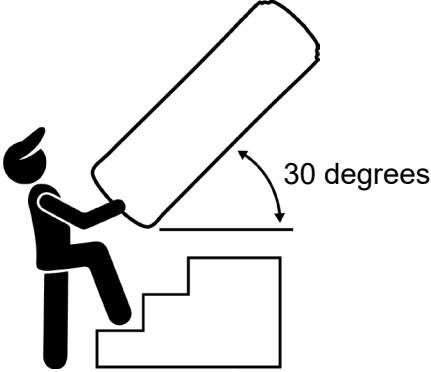
Forklift Transportation	Manual Transportation
<p>The unit must remain mounted on the pallet and lifted at minimal speed. Due to its top heaviness, the unit must be secured against tipping over and placed on a level surface.</p>	<p>Ensure that the maximum permissible inclination angle of 30 degrees is not exceeded. If transport in an inclined position cannot be avoided, the unit should be left to rest at least one hour after it has been moved into final position before operation.</p> 

## 5.3 Location of Installation

The Evo270-1 is designed for external installation, however, where possible installing the unit under the house eaves or in a sheltered environment may help prolong the life of the system.

Heat pumps operate most efficiently with warmer air temperatures, and the outlet air from the unit will always be colder than the inlet air. Therefore, it is advisable to install the unit so it receives the warmest air temperatures possible and that the cold air is not able to recirculate back into the unit.

### 5.3.1 Indoor Installation

- The unit may be able to be installed in an unventilated room exceeding 25m<sup>3</sup> in volume.
- Venting of cold air is advised to prevent the air temperature dropping and lowering the efficiency of the unit.
- Think of the unit as a 3kW air conditioner for the effect it will have on a closed room.

TO COOL A ROOM	TO MAINTAIN NORMAL ROOM TEMPERATURE
<p>Install the unit so the outlet from the heat pump is blowing INTO the room. The room MUST have some form of air outlet otherwise the performance of the unit will suffer significantly.</p>	<p>Install the unit so the outlet from the heat pump is blowing OUTSIDE the room. The room MUST have some form of air inlet otherwise the performance of the unit will suffer significantly.</p>

### 5.4 Airflow Clearances

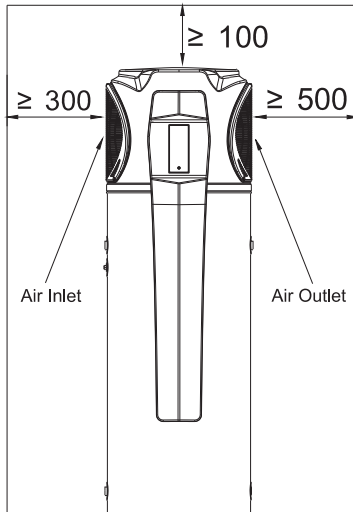

The Evo270-1 must be installed with sufficient clearances to allow airflow to circulate through the unit, it is advised to keep a minimum gap between walls/fences etc of:

- **300mm on the air inlet side**
- **500mm on the air outlet side**
- **100mm overhead & rear clearance**

Without sufficient airflow, discharged cold air will recirculate into the unit and consequently lower the heating efficiency or cause potential compressor failure.

If the installation location does not comply with these suggested clearances, contact EvoHeat’s Technical Support to discuss possible solutions.

Incorrect airflow clearances will potentially void manufacturer warranty.

### 5.5 Cable Connection

The power cable for power supply of the unit is stored in the back of the unit. The unit must be installed in accordance with Australian standards. If the power cord is damaged, it must be replaced by a qualified electrician. Wi-Fi cable connection/plug should be protected from weather and potential water ingress using the supplied heat shrink.

### 5.6 Filling the Tank

Open a hot water tap inside the house. Open the cold-water inlet valve into the Evo270-1 to fill the tank. When water begins flowing out of the hot water tap inside the premises, turn off the hot water tap.

### 5.7 Initial Start-Up

#### PRE-INSPECTION

Check the water supply to the tank and pipe connections for possible leaks.

Check that the following devices are installed and operating correctly:

- Drainpipes
- P&T Valve
- Filter on inlet
- Water softening and pressure reducing devices if required.

Check that all power connections are secure before switching on.

Check that the installation space is adequate.

#### TRIAL OPERATION

Switch on the unit by using the controller.

If any unusual noises occur, switch the power off and consult your provider.

The parameters have been pre-set to a temperature of 60 degrees. Check that the unit is operating by looking for an increase in water temperature over time.



## 6. Operation

### 6.1 The Controller

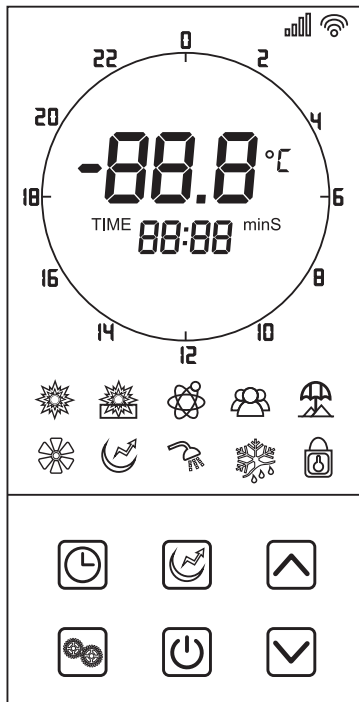

	<b>ON/OFF</b>	Turn the unit on or off.
	<b>UP</b>	Select options to increase values
	<b>DOWN</b>	Select options to decrease values
	<b>CLOCK</b>	Set the clock or the timer.
	<b>HYDROBOOST</b>	Turn on/off the electric heater
	<b>MODE</b>	Switch unit running modes or save setting parameters
	<b>TOUCH TIMING</b>	Touch timing settings

	<b>DEFAULT MODE ECO HEATING MODE</b>	The heat pump system will start according to the water temperature and target temperature. The electric heater always will be off.  The default mode of operation is ECO mode. Any change in operation mode will be in effect for the current heating cycle only; i.e., the unit will return to the default ECO mode once the current cycle is completed.			
	<b>HEATING MODE</b>	The unit will start according to the water temperature and target temperature. The electric heater will not start immediately. After 200 minutes, the unit will judge if it has reached target temperature. If not, the electric heater will start.			
	<b>INTELLIGENT MODE</b>	The unit will automatically judge the operation mode according to the ambient temperature.			
	<b>HIGH REQUIREMENT MODE</b>	The difference between heating mode and high requirement mode is the delay time of electric heater. In the high demand mode, the electric heater will start without delay, which can help the user to heat water quickly in a short time.			
	<b>VACATION MODE</b>	Enable Vacation mode		<b>SET TEMP REACHED</b>	Set temperature has been reached and the unit will shut off automatically
	<b>FAN</b>	Fan is on		<b>LOWER TANK TEMP</b>	Temperature of the lower tank
	<b>HYDROBOOST</b>	The Hydroboost setting is on	<b>min</b>	<b>MINUTE</b>	Minute value is being set
	<b>DEFROST</b>	The unit is defrosting	<b>S</b>	<b>SECOND</b>	Second value is being set
	<b>LOCK</b>	Keyboard is locked		<b>WI-FI</b>	State of Wi-Fi connection *Only available as an optional upgrade
<b>SET</b>	<b>PARAMETER SETTING</b>	Parameter is adjustable			

## 6.2 Operating Functions

EvoHeat have developed a YouTube Channel with video walkthroughs of the different controller functions.



Scan the QR code or head to our channel to view the videos we have available  
<https://www.youtube.com/@evoheatpumps>

### 6.2.1 Locking the Controller

To both lock and unlock the controller, press and hold the button for 5 seconds.

When the controller is locked, a lock symbol will appear on the bottom right.

### 6.2.2 Startup & Shutdown

Press and hold for 0.5 seconds in the standby screen of the controller to turn the unit on. The main display will now show the water outlet temperature.

Press and hold for 0.5 seconds in the running screen of the controller to turn the unit off. The main display will now show "OFF".

The unit will dim the screen and display the standby screen when the controller has not been touched for a minute. Touch the power button to wake it.

Note: The ON/OFF button can only be used to turn the unit on/off in standby or on the running screen of the controller.

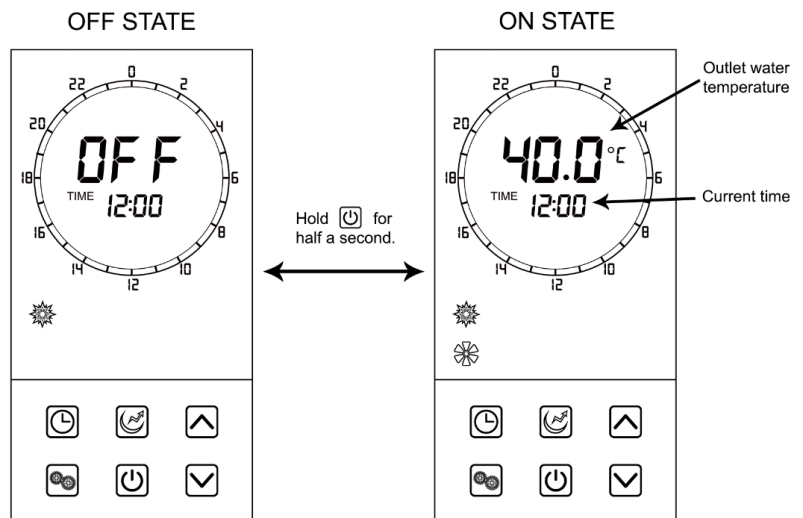

### 6.2.3 Switching Modes



We recommend running the unit in Eco Heating mode where possible for maximum energy efficiency.

From the running screen, press to select one of the modes: Heating, Eco Heating, Intelligent, High requirement, Vacation.

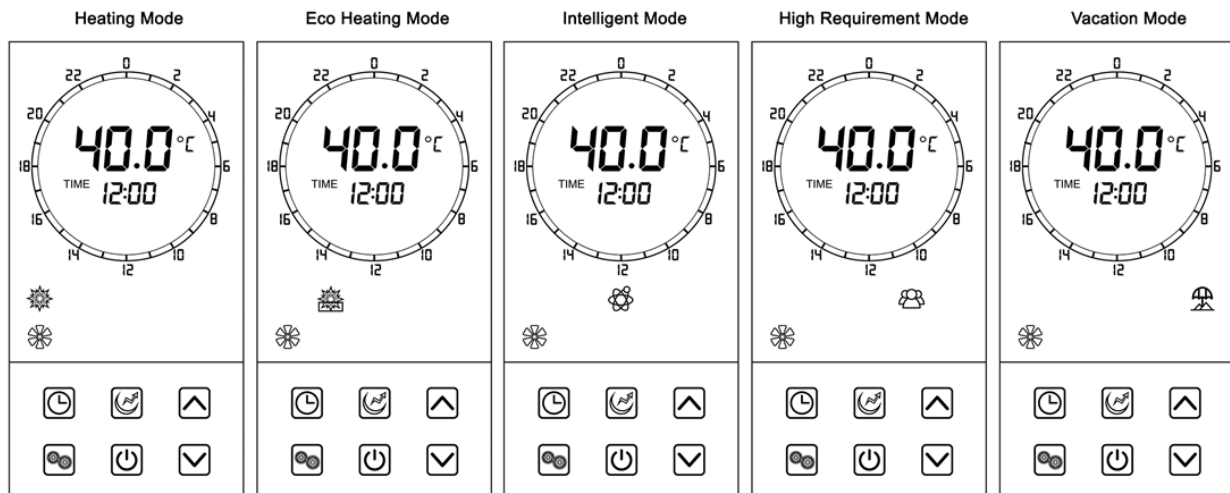

Press to alternate between different modes.

### 6.2.4 Setting & Checking the Target Temperature

In the standby or running interface, press or once to check the target temperature of the outlet water.

Press or again to change the target temperature.

After making changes to the desired temperature, press to confirm or to cancel, then return to the previous screen.

If the keypad is left idle for 5 seconds, the controller will exit the menu automatically and apply any changes that were made.

*Example: The target temperature is 40°C, the actual outlet water temperature is 18°C.*

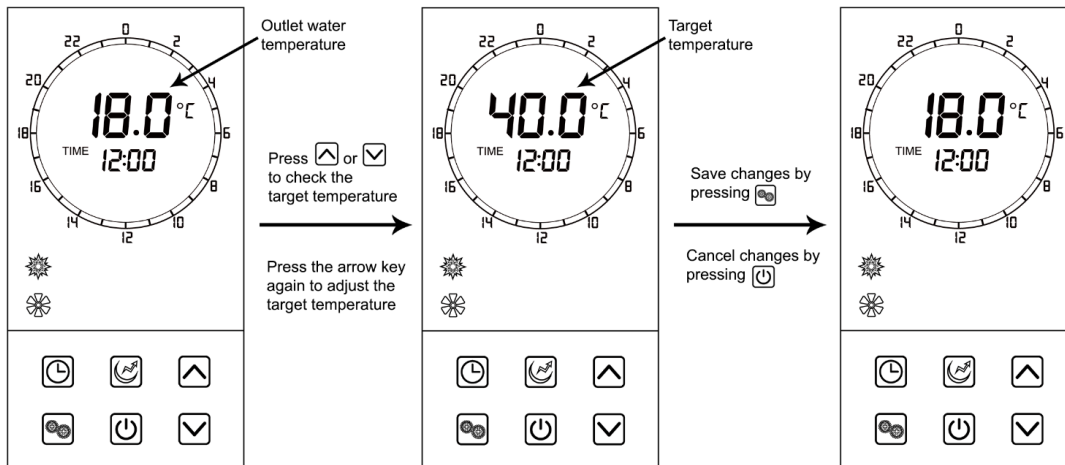

### 6.2.5 Hydroboost Setting



Also known as the Electric heater, the Hydroboost setting allows higher levels of hot water to be produced. When there are high hot water usage requirements (such as guests staying), this function may come in useful.

The Hydroboost setting can be turned on when the unit is in heating or in standby mode.

Press once to turn on Hydroboost on or off.

When activated, will light up on the main display.

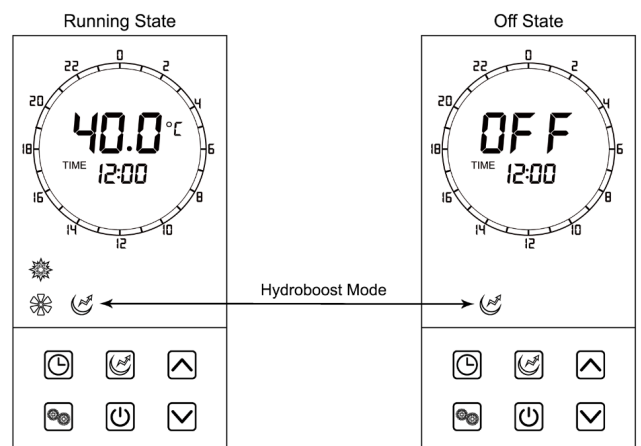

### 6.2.6 Force Defrost



In the extremely unlikely circumstance of the unit icing up (for example, if the unit was installed inside with no ventilation), this function can be applied.

When the unit is off, press and hold for 10 seconds to enable the forced defrosting function. The defrosting symbol will light up. Press for 10 seconds again to exit the forced defrosting function.

### 6.2.7 System Date & Time

In the standby or running interface, press once, the hour digit will flash indicating it is being altered. Press the or to change the hour setting, then press to confirm. Repeat this to change the minute value.

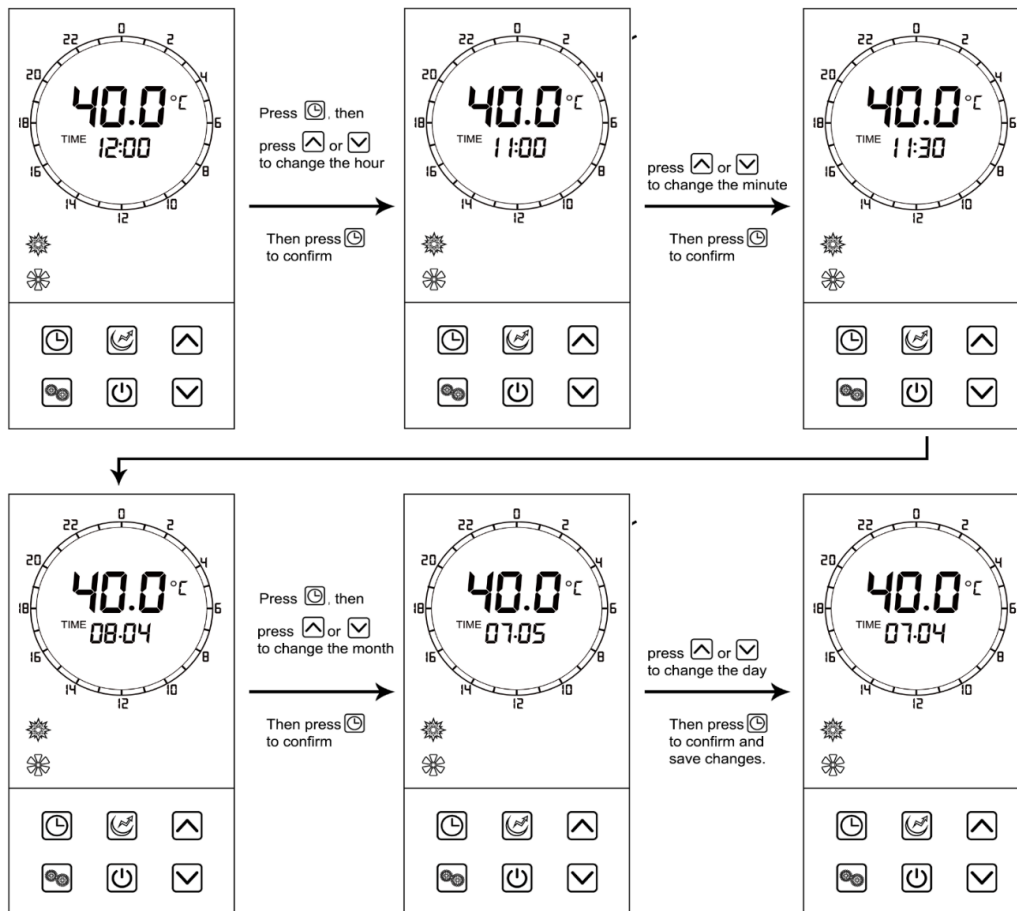

### 6.2.8 Setting & Cancelling Timers

Timers can be set in standard mode, economic mode, auto mode & fast heating mode. They can be set by using buttons or using the touch timing circle. The unit will run during the lit time periods and stop in the dim areas.

Touch Method	Button Method
<ul style="list-style-type: none"> <li>• Press  and hold for 2 seconds (the timer display will flash)</li> <li>• When the timer display flashes, choose your <b>start-up time</b> and <b>end time</b></li> <li>• Press  to save the setting and exit back to the main interface.</li> </ul>	<ul style="list-style-type: none"> <li>• Press  and hold for 2 seconds (the timer display will flash)</li> <li>• When the timer display flashes, choose the <b>start-up time</b> and <b>end time</b> by pressing  or  and then .</li> <li>• Press  to save the setting and exit back to the main interface.</li> </ul>

Example: Setting the unit to run from 7-11am & 4pm-6pm using Touch mode.

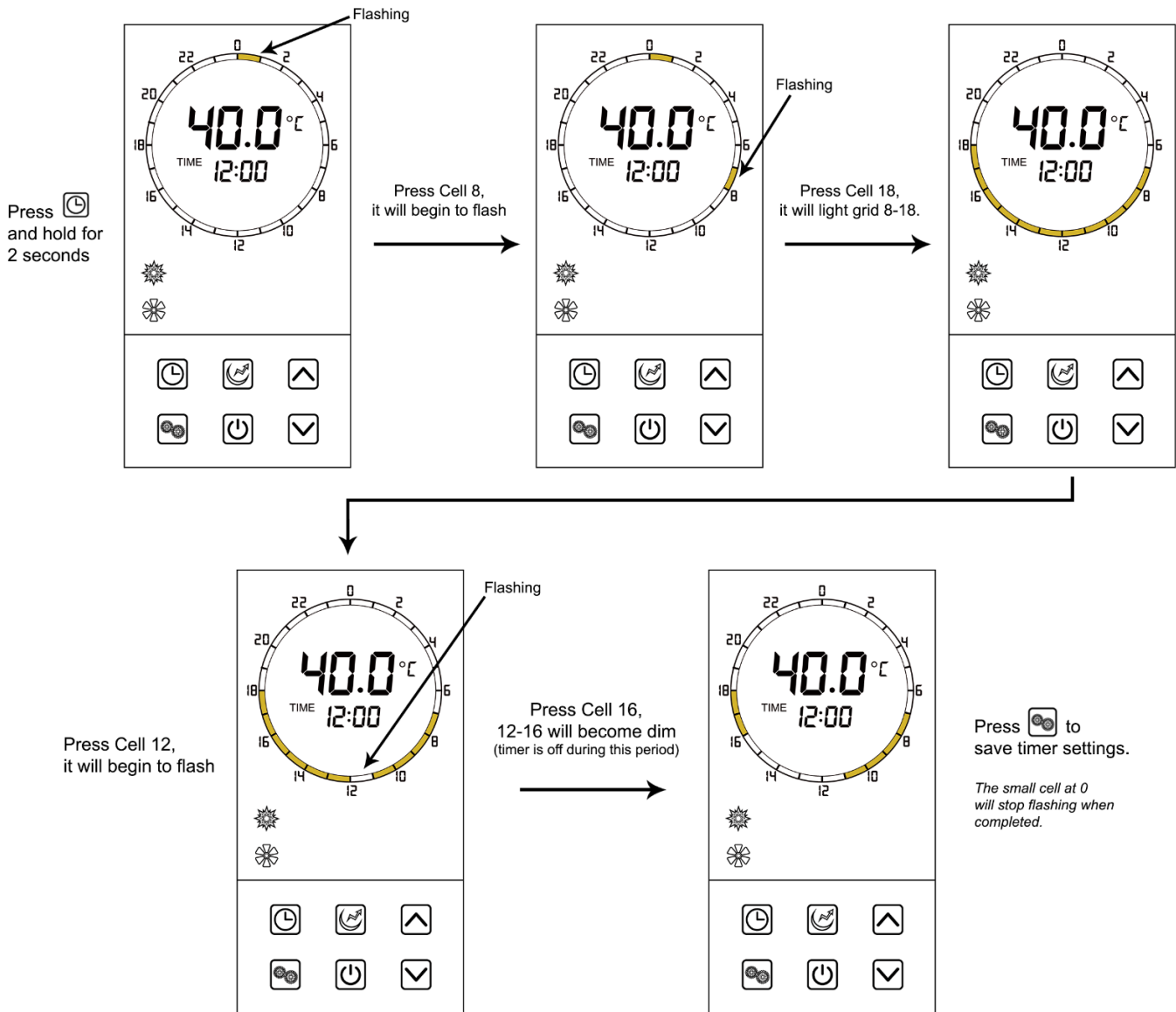

To **cancel** a timer once it has been set, hold down the CLOCK button for 2 seconds until the timer display begins flashing (as you would set the timer).

Press the POWER button while the timer is flashing to cancel it. The yellow timing periods will disappear when the timer has been cancelled.

### 6.2.9 Vacation Mode



Vacation Mode allows you to turn the unit off to conserve power for an extended period of time, and restart operation on a date you specify. This ensures you have hot water waiting for you upon your return.

Ensure the unit is 'OFF' before setting vacation mode. The date you set in this mode will determine what date the unit starts back up.

After selecting vacation mode, press and hold for 2 seconds, the 'month' value will begin to flash in the display area. Press the **UP** or **DOWN** arrows to display the desired month, then press to confirm and move to altering the 'day' value.

The 'day' value will flash when it is selected, use the arrow keys to select your desired start day, then press to save all changes and exit back to the main interface.

Note: Format is mm/dd  
Example: The unit will start up on September the 28<sup>th</sup>.

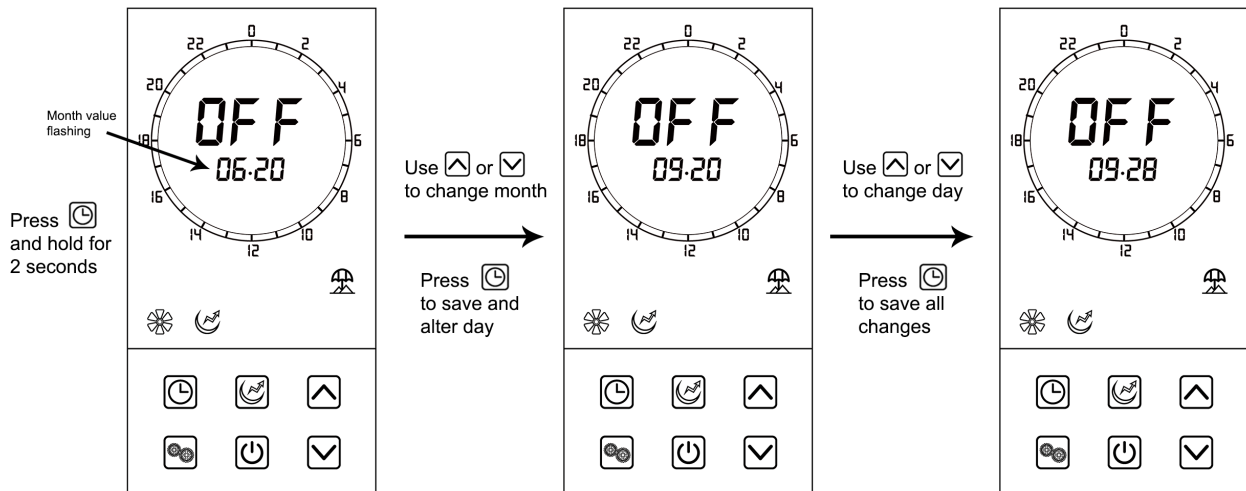

### 6.2.10 Sanitech System

The Sanitech feature's purpose is to keep the water free of bacteria, such as Legionella, by heating at least 45% of the tank water to 60°C each day.



An instance when you may want to alter the Sanitech function is if you have solar and would prefer the Sanitech to run during the day, for example at 12pm, rather than midnight.

If you would like to change this function, **contact EvoHeat's service department** for guidance. Incorrectly attempting to adjust these settings yourself could significantly disrupt the unit's operation.

### 6.2.11 Fan/Ventilation Function



This function may come in useful if the system is installed inside and the fan settings need to be adjusted to suit ducting or external ventilation. This function allows you to set the fan speed as Off, Low Speed or High Speed.

If you would like to change this function, **contact EvoHeat's service department for guidance.** Incorrectly attempting to adjust these settings yourself could significantly disrupt the unit's operation.

## 7. Troubleshooting

Malfunction	Fault Display	Reason	Elimination Methods
Bottom water temp. failure	P01	The water bottom temp. sensor is open or short circuit.	Check or change the water bottom temp. sensor
Top tank water temp. failure	P02	The water top tank temp. sensor is open or short circuit	Check or change the water top tank temp. sensor
Ambient temp. failure	P04	The ambient temp. sensor is open or short circuit	Check or change the ambient temp. sensor
Coil temp. failure	P05	The pipe temp. sensor is open or short circuit	Check or change the pipe temp. sensor
Refrigerant absorb temp. failure	P07	The evaporator temp. sensor is open or short circuit	Check or change the evaporator temp. sensor
Anti-freeze temp. failure	P09	The anti-freeze temp. sensor is open or short circuit	Check or change the anti-freeze temp. sensor
Solar temp. failure	P034	The solar temp sensor is open or short circuit	Check or change the solar temp sensor
High pressure protection	E01	The exhaust pressure is high, high pressure switch action	Check high pressure switch and cooling return circuit
Low pressure protection	E02	The suction pressure is low, low pressure switch action	Check low pressure switch and cooling return circuit
Water flow failure	E03	No water or little water in water system	Water, check for flow volume pump failure
Electric-heater overheat protection	E04	Water flow volume not enough, water system pressure difference is small	Water, check if the flow volume system is jammed
Anti-freeze protection	E07	Water flow volume not enough, water system pressure difference is small	Water, check if the flow volume system is jammed
Communication failure	E08	Wired remote control with master signal failure	Check the connection line between the wired remote control and mother board
Winter defrost protection	E09	Ambient temperature is too low	

**8. Appendix**

**8.1 Wiring Diagram**

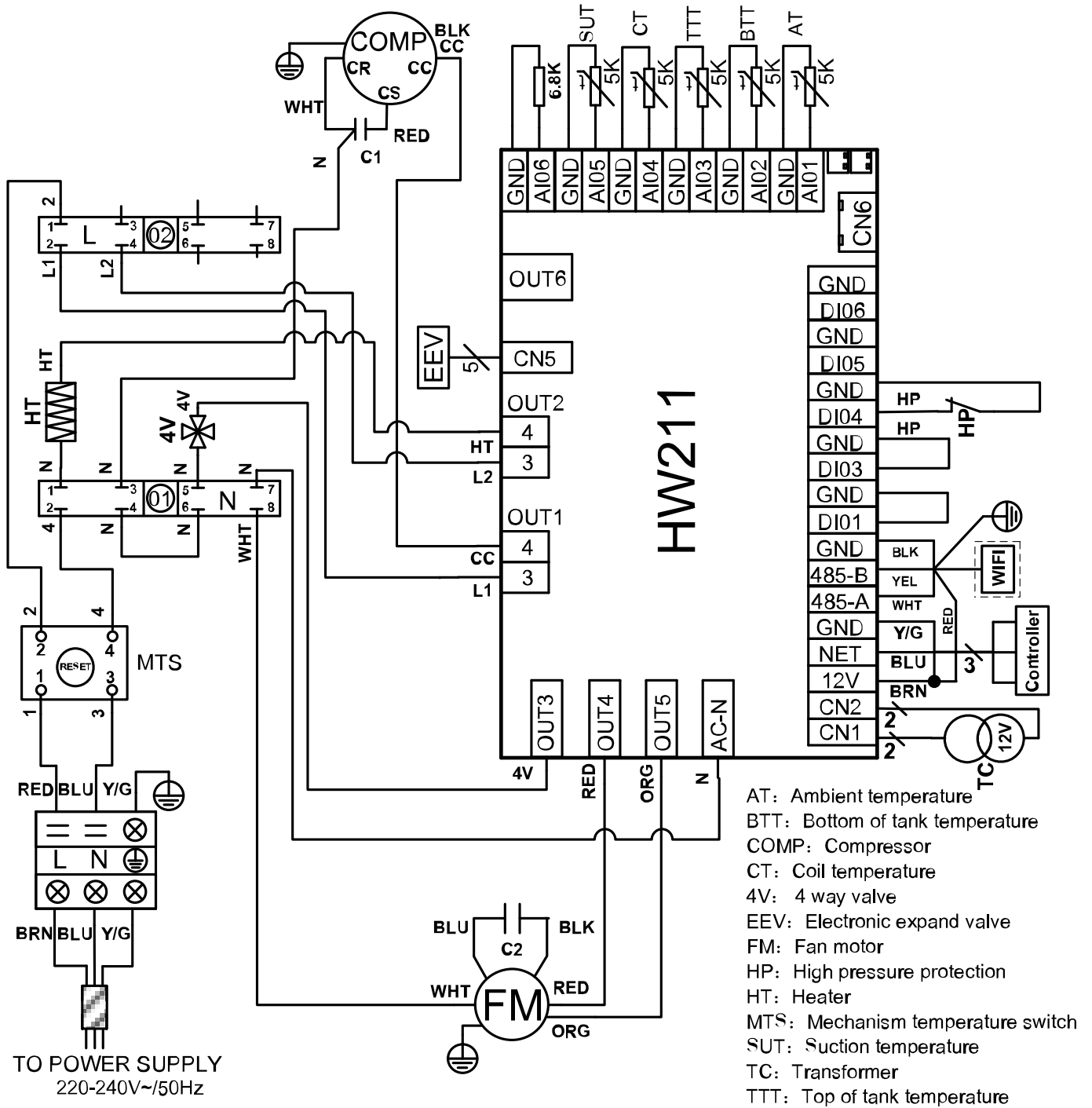



### 8.2 Wi-Fi Module Connection (Optional)

**Note: If you do not have a Wi-Fi module to install, apply heat shrink to the plug, this will protect it from water ingress and simply push the cord entirely behind the front panel.**

The optional Wi-fi Control upgrade can be purchased to allow you to remotely control your EvoHeat hot water heat pump from your phone.

Newly installed units will have a small cable protruding from behind the front panel with a small waterproof cover.

If you are installing the Wi-Fi module, simply connect the cable of the Wi-Fi module to the one that protrudes.

Once the Wi-Fi module has been connected, ensure that the connection plug has the heat shrink applied to the plug and the cable is placed behind the front cover.

The module must be placed with the cord coming downwards to protect it from water tracking.

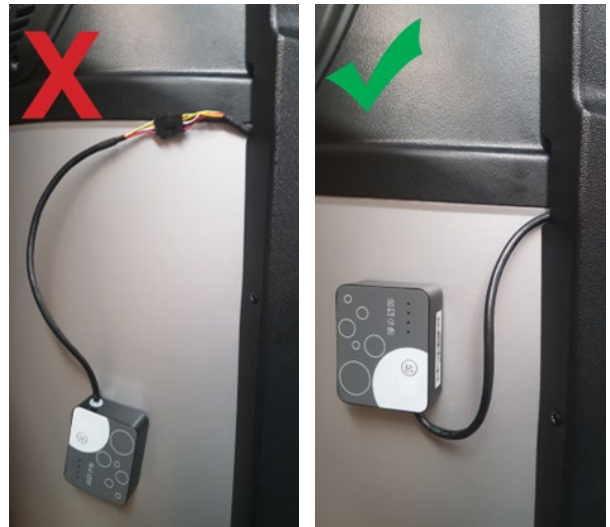

### 8.3 Use of the P&T Valve



The P&T valve is used to prevent the temperature or pressure becoming too high inside the tank. When the temperature or pressure reaches the set value, the valve will open automatically to force the pressure or temperature to decrease

The handle of the safety valve should be tested once every six months to remove the calcium carbonate deposits and guarantee there is no blockage in the device. Take care to avoid burns as the temperature of the discharging water is very high.

Vent pipes should be thermally insulated to prevent safety risks caused by freezing pipes in winter.

If the P&T valve requires replacement it should be replaced with the same rated performance, size, and specification as the original supplied equipment.



**WARNING:** Failing to operate the relief valve easing gear at least once every six months may result in the water heater exploding. Continuous leakage of water from the valve may indicate a problem with the water heater.

### 8.4 Using the Overheating Protector

The overheating protector is used to turn the power off in an emergency or with power supply issues, preventing the water from being heated too high.

A thermal cut-out could indicate a possibly dangerous situation. Do not reset the thermal cutout until the unit has been serviced by a qualified technician. Contact EvoHeat for a service if this occurs before attempting to reset.

To return the unit to its normal operation status by resetting manually:

- a) To access the overheat protector, remove the front dark grey controller panel.
- b) Remove the 3 screws on the front panel and push the front cover upwards.
- c) Remove remaining screws which cover the overheat protector panel.

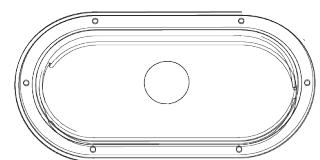

Remove screws and open cover

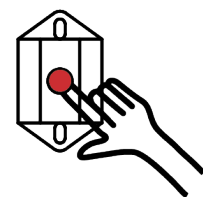

Press the red button to reset

### 8.5 Draining the Water Tank

1. Close the cold-water inlet valve into the Evo270-1.
2. Open a hot water tap inside the premises.
3. Undo the drain plug on the base of the unit to drain the water from the system.



The water from the hot water tap and the drain plug will be hot. Be careful of burns and scalds. Wear protective clothing.

### 8.6 Earthing Methodology

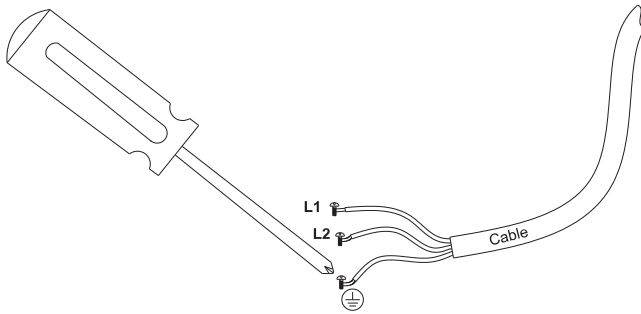

## 9. Maintenance

Your Evo270-1 will operate most efficiently if regularly inspected as part of your home maintenance schedule.

### ANNUAL MAINTENANCE

It is recommended that the minor maintenance be performed every 12 months by the dwelling occupant.

The minor maintenance includes:

- Operate the easing lever on the temperature pressure relief valve. It is very important you raise and lower the lever gently. Exercise care to avoid any splashing of water, as water discharged from the drain line will be hot. Stand clear of the drain lines point of discharge when operating the valve's lever.
- Operate the easing level on the expansion control valve (if fitted). It is very important you raise and lower the lever gently.
- Conduct a visual inspection of all plumbing and electrical connections.
- Check the condensate drain line to ensure it is not blocked.
- Check that air vents and evaporator is not blocked or obstructed, and if necessary, isolate the power to the system and clear with a brush.
- Conduct a general external clean of the unit with a damp cloth.

### THREE-YEAR SERVICE



It is a warranty requirement that a three (3) year service must be conducted on the Evo270-1.

Just as a car needs regular servicing, your heat pump also requires a three-year service to maintain efficiency and ensure long-term performance.



Warning: Servicing of a water heater must only be carried out by qualified EvoHeat personnel. Phone EvoHeat Service on 1300 859 933 for our closest Accredited Service Agent.

**Note:** The three-year service and routine replacement of any components such as the anode and relief valve(s) are not included in the EvoHeat warranty. Only genuine replacement parts should be used on this water heater.

The service includes the following actions:

- Replace the temperature limiting valve.
- Replace the temperature pressure relief valve.
- Inspect the anode and if required, replace the anode. If the anode is not replaced, it should be replaced within three years of this service.
- Check the heating cycle of the unit.
- Visually check the unit for any potential problems.
- Inspect the plumbing and electrical all connections.
- Check the condensate on drain line to ensure it is not blocked.

**Note:** The water heater may need to be drained during this service. After the completion of the service, the water heater will take some time to reheat the water. Depending upon the power supply connect on, hot water may not be available until the next day.

## 10. Warranty



**Refer to the EvoHeat website for warranty details**

<https://evoheat.com.au/warranty-terms/>

### REGISTER YOUR WARRANTY



EvoHeat highly recommend customers complete their warranty details online to ensure efficient warranty claim processing. To register your warranty, scan our QR Code or head to our website and fill in the Warranty Registration Form: <https://evoheat.com.au/warranty-registration/>

1. Warranty terms are from date of purchase.
2. This warranty excludes any defect or injury caused by or resulting from misuse, abuse, neglect, accidental damage, improper voltage, vermin infestation, incompetent installation, any fault not attributable to faulty manufacture or parts, any modifications which affect the reliability or performance of the unit.
3. This warranty does not cover the following:
  - a) Natural Disasters (hail, lightening, flood, fire etc.)
  - b) Damage resulting from any animal or creature (including vermin, reptiles and insects)
  - c) Rust or damage to exterior coatings, materials, and cabinet caused by corrosive atmosphere or weather/environmental conditions.
  - d) When serviced by an unauthorised person without the permission of Evo Industries.
  - e) When a unit is installed by an unqualified person.
  - f) When failure occurs due to improper or incorrect installation.
  - g) Where failure occurs due to failure of any other equipment connected in relation with the EvoHeat unit (e.g. power supply, water pump etc.).
  - h) Where failure occurs due to improper maintenance or misuse (refer Operating Instructions).
  - i) Where the unit has not had its three-year general maintenance service performed by a certified plumber. Proof of this service will be required for warranty claims beyond three years.
  - j) 'No Fault Found' service calls where the perceived problem is explained within the operation instructions.
  - k) Costs associated with delivery, handling, freighting, or damage to the product in transit.
  - l) Where the unit has been relocated from its originally installed location.
4. If warranty service is required, you should:
  - a) Contact Evo Industries Australia on 1300 859 933 or via our Contact page on our website.
  - b) Provide a copy of your receipt as proof of purchase.
  - c) Have completed the online Service Request Form via the website [www.evoheat.com.au/service-request/](http://www.evoheat.com.au/service-request/)
5. Onsite technical service is available within the normal operating area of your Evo Authorised Service Agents. Service outside this area will incur a traveling fee.
6. Our goods come with guarantees that cannot be excluded under the Australian Consumer Law. You are entitled to a replacement or refund for a major failure and compensation for any other reasonably foreseeable loss or damage. You are also entitled to have the goods repaired or replaced if the goods fail to be of acceptable quality and the failure does not amount to a major failure.