



INSTALLATION & OPERATION MANUAL



EVO270-E

HOT WATER HEAT PUMP



Contents

1. Introduction	2
2. Dimensions.....	2
3. Quick Start Guide	3
4. Safety Instructions.....	4
5. Installation	5
5.1 System Installation	5
5.2 Handling & Transportation	5
5.3 Location of Installation	5
5.4 Airflow Clearances	6
5.5 Cable Connection.....	6
5.6 Filling the Tank.....	6
5.7 Initial Start-Up	6
6. Operation.....	7
6.1 The Controller	7
6.2 Operating Functions.....	8
6.2.1 Locking the Controller	8
6.2.2 Startup & Shutdown	8
6.2.3 Switching Modes	8
6.2.4 Setting & Checking the Target Temperature	9
6.2.5 Hydroboost Setting.....	9
6.2.6 Force Defrost	9
6.2.7 System Date & Time	10
6.2.8 Setting & Cancelling Timers.....	10
6.2.9 Vacation Mode	11
6.2.10 Sanitech System	12
6.2.11 Fan/Ventilation Function	12
7. Troubleshooting	13
7.1 Troubleshooting Q & A.....	13
7.2 Error Codes	14
8. Appendix	15
8.1 Wiring Diagram	15
8.2 Use of the P&T Valve.....	15
8.3 Using the Overheating Protector.....	16
8.4 Draining the Water Tank	16
8.5 Wi-Fi Module Connection (Optional).....	16
9. Maintenance.....	17
9.1 Maintenance Periods	17
10. Warranty.....	18

1. Introduction

This manual contains information relating to the installation, troubleshooting, operation, and maintenance of this EvoHeat unit. Instructions in this manual must always be followed. Failure to comply with these recommendations will invalidate the warranty. Should you have any questions or require technical support, call the EvoHeat office on 1300 859 933 to speak to our team.

TECHNICAL DATA		EVO270-E
Storage Capacity	L	270
Rated Outlet Water Temp.	°C	60
Heating Capacity	kW	4.0
Heating Power Input	kW	0.85
Rated Power Input	kW	2.38
C.O.P at 20°C Air		4.7
Noise Rating	dB(A)	46
Running Current	A	3.6
Rated Current Input	A	9.9
Power Supply		220-240V~50Hz
Water Inlet/Outlet Size	inch	3/4"
Auxiliary Heating	kW	1.0
Net Weight	kg	100
Moisture Resistance	IPX	IPX4
Electrical Shock Proof	I	I
Refrigerant	G	R290 / 480g
Compressor		Rotary



The EVO270-E is the next evolution in water heating with advanced energy efficiency technologies and built-in smart features to ensure you're provided with clean, safe, and economical hot water all year round.

Conforms to AS 3498-2020 Australia and New Zealand

Measurement conditions: Instant heating:

- Ambient air temperature: 20°C/15°C
- Water inlet: 15°C
- water outlet: 55°C
- highest setting temperature: 75°C

2. Dimensions

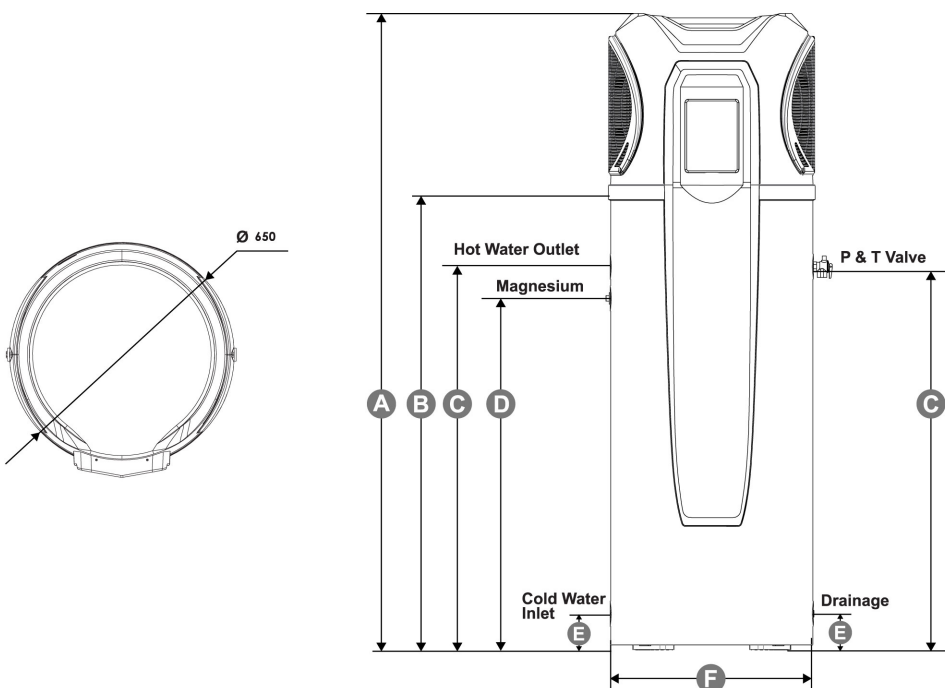













EVO270-E	unit: mm
A (HEIGHT)	2010
B	1451
C	1211
D	1111
E	115
F (DIAMETER)	650

**DO NOT DRILL**

Do not drill any fixings or attachments into the outer casing of the tank. Drilling into the outer casing of the tank may damage the heating coil and WILL VOID WARRANTY.

INITIAL STARTUP

1. Press and hold  for one second to power on the unit.
2. To set the time:
 - a. Press  once so the hour digit starts flashing,
 - b. Use   to adjust the hour and press  to confirm,
 - c. Repeat for the minute, day, month and year,
 - d. Press  at any stage to cancel.
3. Press  until  is displayed. This will activate “Eco Heating” (Heat Pump only) mode and will provide the most efficient heating.
4. During periods of unusually high hot water demand (such as additional occupants staying with you), you can activate “High Requirement” mode by pressing  until  is displayed.
5. In any event where there is a failure within the system, the Electric Element (Hydroboost Mode) can be engaged with “one push activation” of the  button until  is displayed. This will provide emergency water heating until service can be attended.
6. For adjustment of timers or activating vacation mode, please refer to our online tutorials at: www.evoheat.com.au/tech-support

4. Safety Instructions

Ensure that all safety instructions and recommendations are always adhered to. Failure to comply with these recommendations could void the warranty and cause injury or death. Always use a suitably qualified Electrician to perform any electrical work, they must read the manual before connecting.



Ensure all cabling, circuit breakers, and protections are of a suitable size and specification in accordance with electrical wiring legislation for the heater being installed. Ensure to check that there is adequate voltage and current available at the heater connection to run the unit.

General Compliance:

- Adhere to all safety instructions and recommendations to avoid voiding the warranty and risk of injury or death.
- Installation, repair, service or relocation must be performed only by qualified technicians, in line with Australian Standards and Industry Codes, including electrical safety, plumbing, and heat pump installation.
- The unit must be installed to conform to all relevant Australian Standards and Industry Codes including but not limited to: Electrical & Electrical Safety, Plumbing & Hot Water Storage, Heat Pump Installation & Operation.
- Installation must also comply with any local, state or federal codes at the installation site. Failure to comply can void your warranty, damage your unit, or possibly cause injury or death. Plumbing must comply with AS/NZS3500.4.
- Use the unit within the environmental temperature range of -5°C to 43°C.
- Install temperature and pressure protective equipment as required by local codes, including a temperature and pressure relief valve certified to ANSIZ21.22 standards.
- Avoid using unsafe water sources such as lake or groundwater.
- Be cautious of hot fittings.
- Observe a 3-minute delay when manually restarting the unit.
- Test the P&T valve biannually for blockages.
- Use a 5A/250VAC safety cable meeting explosion-proof requirements.
- Secure all connections before powering on.
- The installer must explain operation and maintenance to the end user.
- For systems unused for over two weeks, open a hot water faucet for several minutes before using any electrical appliance to prevent flammable hydrogen gas build-up.
- In the event of the unit malfunctioning, shut off the power supply and contact your supplier or EvoHeat.
- Do not drill any fixings or attachments into the outer casing of the tank. Drilling into the outer casing of the tank may damage the heating coil and **WILL VOID WARRANTY.**

Electrical & Installation Safety:

- Install a circuit breaker for the unit.
- Ensure good power connection and earthing.
- Disconnect all supply circuits before accessing terminals.
- Use a qualified electrician for electrical work, ensuring cabling, circuit breakers, and protections are suitable.
- Avoid leaks in plumbing and drainage fittings.
- Do not install near flammable gases or aerosols.
- Ensure a level, stable base.
- Comply with national wiring regulations and local codes.
- Keep the area around the unit dry, clean, and well-ventilated for optimal heat transfer and energy efficiency.

Operational Safety & Maintenance:

- A Pressure & Temperature (P&T) valve must be installed in the tank. When the tank pressure reaches 0.85MPa or when the tank temperature reaches 99°C, the P&T valve will open automatically to reduce the pressure or temperature.

Additional Precautions:

- Evo Industries Australia Pty Ltd is not responsible for damages or injuries due to incorrect installation.
- Follow the recommended maintenance programme in the manual.
- The appliance should have disconnection means with contact separation in all poles for full disconnection under overvoltage category III conditions, in accordance with wiring rules.

WARNING

THIS PRODUCT CONTAINS A BUTTON BATTERY

If swallowed, a lithium button battery can cause severe or fatal injuries within 2 hours.

Keep batteries out of reach of children.

If you think batteries may have been swallowed or placed inside any part of the body, seek immediate medical attention.

5. Installation

5.1 System Installation

Upon receiving the unit, check the packaging for any obvious signs of damage. Inform EvoHeat immediately if there is any evidence of rough handling.



Do not drill any fixings or attachments into the outer casing of the tank. Drilling into the outer casing of the tank may damage the heating coil and **WILL VOID WARRANTY.**



The P&T valve attached with the unit must be installed. Failure to do so will cause damage to the unit and possible personal injury.



Drain the water tank through the drain valve at the bottom part of the unit.



Do not use stainless steel fittings to connect directly with other metals to prevent galvanic corrosion.

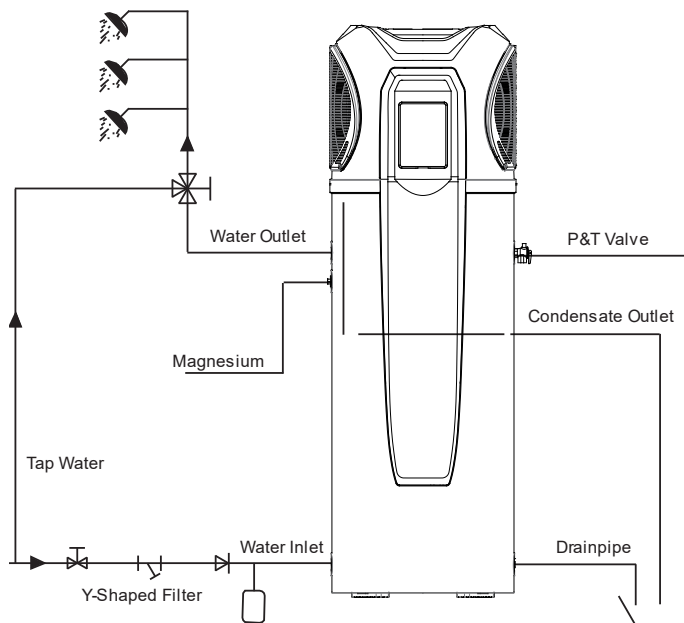

A pressure releasing valve is to be fitted within the installation. Spec of P&T valve: Pressure: 0.85MP
Temperature: 99°C



- Use BSP3/4 internal thread pipes for water inlet and outlet, ensuring they are heat-resistant and durable.
- The P&T valve should also use a BSP3/4 internal thread. Ensure its drainpipe outlet is exposed to air and the flexible drainpipe points downwards.

5.2 Handing & Transportation

The unit should be stored and transported in an upright position, without water, and is allowed a maximum tilt of 30 degrees for short distances. Keep it within ambient temperatures of 0°C to 40°C. For forklift transportation, the unit must remain on its pallet, be lifted slowly, and be secured to prevent tipping over.

When manually transporting, use the wooden pallet and ropes or straps, ensuring the unit doesn't exceed a 60-degree tilt. After any inclined transport, let the unit rest for an hour before operation.



5.3 Location of Installation

The heat pump is designed for external installation, however, where possible installing the unit under the house eaves or in a sheltered environment may help prolong the life of the system.

Heat pumps operate most efficiently with warmer air temperatures, and the outlet air from the unit will always be colder than the inlet air. Therefore, it is advisable to install the unit, so it receives the warmest air temperatures possible and that the cold air is not able to recirculate back into the unit.

5.4 Airflow Clearances

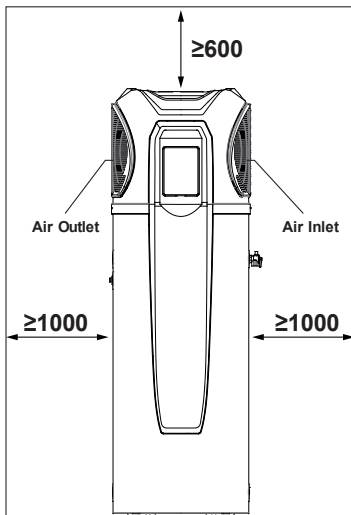

The unit must be installed with sufficient clearances to allow airflow to circulate through the unit, it is advised to keep a **minimum** gap between walls/fences etc of:

- **Air Inlet/Outlet Sides: 1000mm**
- **Overhead Clearance: 600mm**
- **Rear Clearance: 300mm**

Without sufficient airflow, discharged cold air will recirculate into the unit and consequently lower the heating efficiency or cause potential compressor failure.

If the installation location does not comply with these suggested clearances, contact EvoHeat's Technical Support to discuss possible solutions.

Non-compliant installations risk voiding the warranty; ensure adherence to AS/NZS 3500.4

5.5 Cable Connection

The power cable for power supply of the unit is stored in the back of the unit. The unit must be installed in accordance with Australian standards. If the power cord is damaged, it must be replaced by a qualified electrician. Wi-Fi cable connection/plug should be protected from weather and potential water ingress using the supplied heat shrink.

5.6 Filling the Tank

Open a hot water tap inside the house. Open the cold-water inlet valve into the unit to fill the tank. When water begins flowing out of the hot water tap inside the premises, turn off the hot water tap.

5.7 Initial Start-Up

PRE-INSPECTION

Check the water supply to the tank and pipe connections for possible leaks.

Check that the following devices are installed and operating correctly:

- Drainpipes
- P&T Valve
- Filter on inlet
- Water softening and pressure reducing devices if required.

Check that all power connections are secure before switching on.

Check that the installation space is adequate.

TRIAL OPERATION

Switch on the unit by using the controller.

If any unusual noises occur, switch the power off and consult your provider.

The parameters have been pre-set to a temperature of 60 degrees. Check that the unit is operating by looking for an increase in water temperature over time.

6. Operation

6.1 The Controller

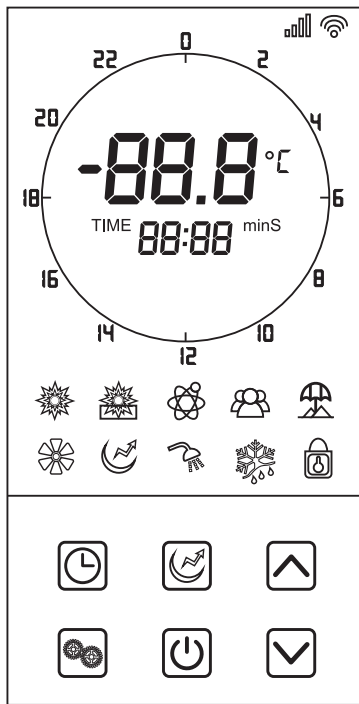

	ON/OFF	Turn the unit on or off.
	UP	Select options to increase values
	DOWN	Select options to decrease values
	CLOCK	Set the clock or the timer.
	HYDROBOOST	Turn on/off the electric heater
	MODE	Switch unit running modes or save setting parameters
	TOUCH TIMING	Touch timing settings

	DEFAULT MODE ECO HEATING MODE	The heat pump system will start according to the water temperature and target temperature. The electric heater always will be off.			
	HEATING MODE	The unit will start according to the water temperature and target temperature. The electric heater will not start immediately. After 200 minutes, the unit will judge if it has reached target temperature. If not, the electric heater will start.			
	INTELLIGENT MODE	The unit will automatically judge the operation mode according to the ambient temperature.			
	HIGH REQUIREMENT MODE	The difference between heating mode and high requirement mode is the delay time of electric heater. In the high demand mode, the electric heater will start without delay, which can help the user to heat water quickly in a short time.			
	VACATION MODE	Enable Vacation mode		SET TEMP REACHED	Set temperature has been reached and the unit will shut off automatically
	FAN	Fan is on		LOWER TANK TEMP	Temperature of the lower tank
	HYDROBOOST	The Hydroboost setting is on	min	MINUTE	Minute value is being set
	DEFROST	The unit is defrosting	S	SECOND	Second value is being set
	LOCK	Keyboard is locked		WI-FI	State of Wi-Fi connection *Only available as an optional upgrade
SET	PARAMETER SETTING	Parameter is adjustable			

6.2 Operating Functions

EvoHeat have developed a YouTube Channel with video walkthroughs of the different controller functions.

Scan the QR code or head to our channel to view the videos we have available
<https://www.youtube.com/@evoheatpumps>



6.2.1 Locking the Controller

To both lock and unlock the controller, press and hold the button for 5 seconds.

When the controller is locked, a lock symbol will appear on the bottom right.

6.2.2 Startup & Shutdown

Press and hold for 0.5 seconds in the standby screen of the controller to turn the unit on. The main display will now show the water outlet temperature.

Press and hold for 0.5 seconds in the running screen of the controller to turn the unit off. The main display will now show "OFF".

The unit will dim the screen and display the standby screen when the controller has not been touched for a minute. Touch the power button to wake it.

Note: The ON/OFF button can only be used to turn the unit on/off in standby or on the running screen of the controller.

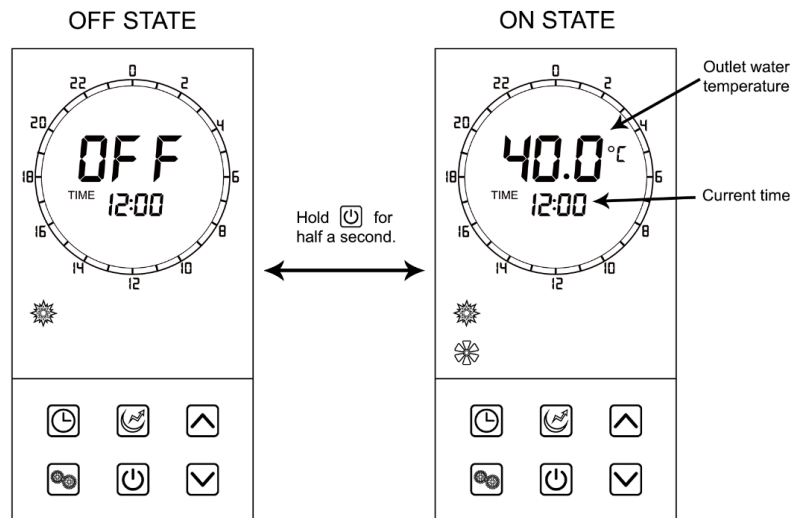

6.2.3 Switching Modes



We recommend running the unit in Eco Heating mode where possible for maximum energy efficiency.

From the running screen, press to select one of the modes: Heating, Eco Heating, Intelligent, High requirement, Vacation.

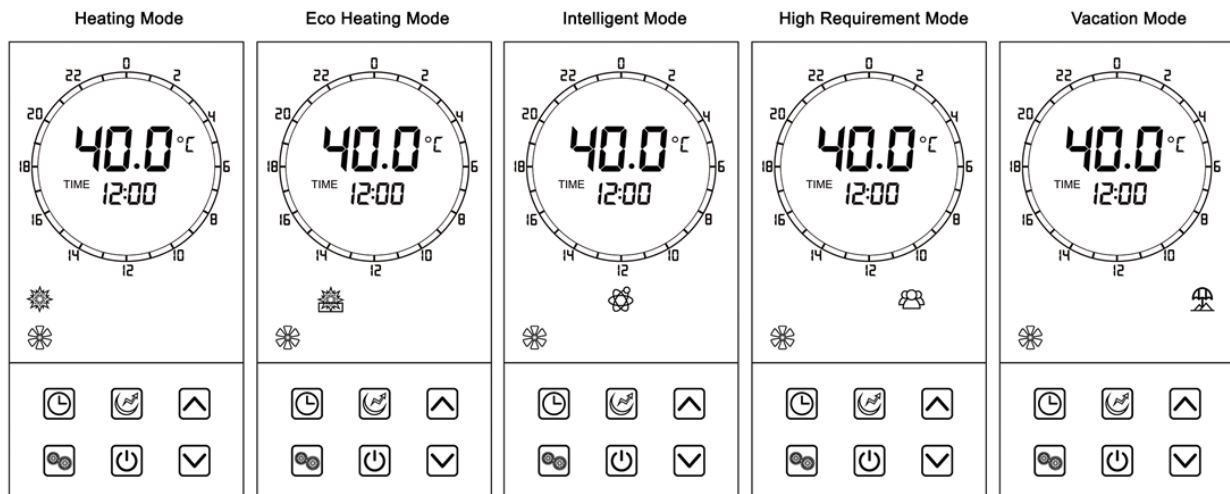

Press to alternate between different modes.

6.2.4 Setting & Checking the Target Temperature

In the standby or running interface, press or once to check the target temperature of the outlet water.

Press or again to change the target temperature.

After making changes to the desired temperature, press to confirm or to cancel, then return to the previous screen.

If the keypad is left idle for 5 seconds, the controller will exit the menu automatically and apply any changes that were made.

Example: The target temperature is 40°C, the actual outlet water temperature is 18°C.

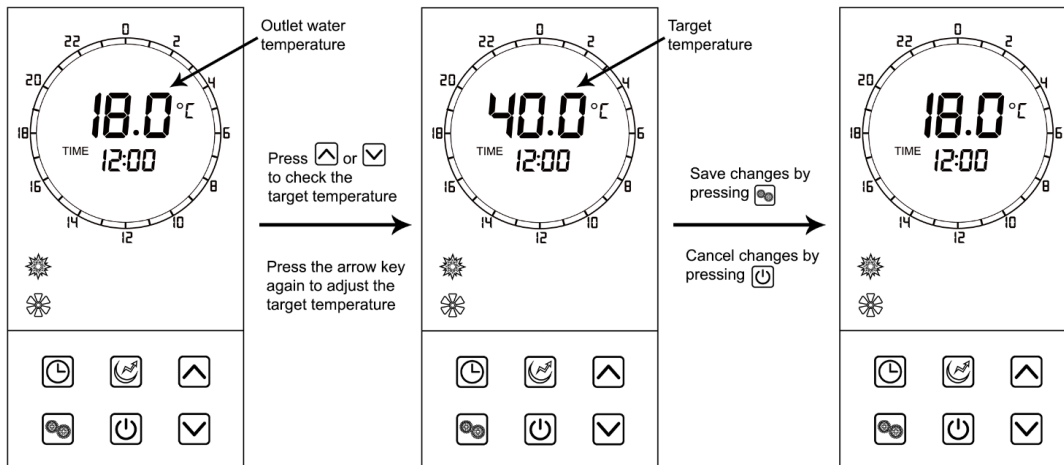

6.2.5 Hydroboost Setting



Also known as the Electric heater, the Hydroboost setting allows higher levels of hot water to be produced. When there are high hot water usage requirements (such as guests staying), this function may come in useful.

The Hydroboost setting can be turned on when the unit is in heating or in standby mode.

Press once to turn on Hydroboost on or off.

When activated, will light up on the main display.

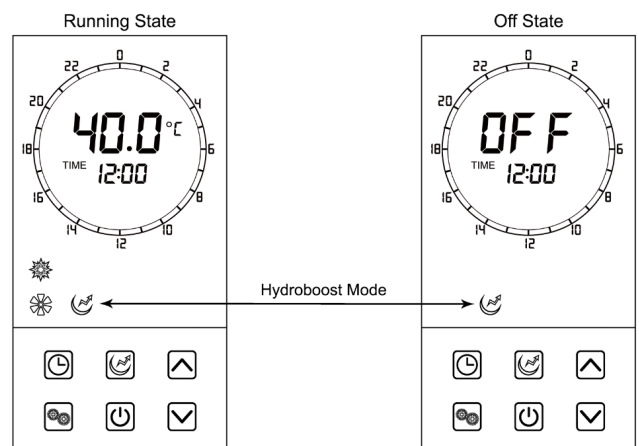

6.2.6 Force Defrost



In the extremely unlikely circumstance of the unit icing up (for example, if the unit was installed inside with no ventilation), this function can be applied.

When the unit is off, press and hold for 10 seconds to enable the forced defrosting function. The defrosting symbol will light up. Press for 10 seconds again to exit the forced defrosting function.

6.2.7 System Date & Time

In the standby or running interface, press once, the hour digit will flash indicating it is being altered. Press the or to change the hour setting, then press to confirm. Repeat this to change the minute value.

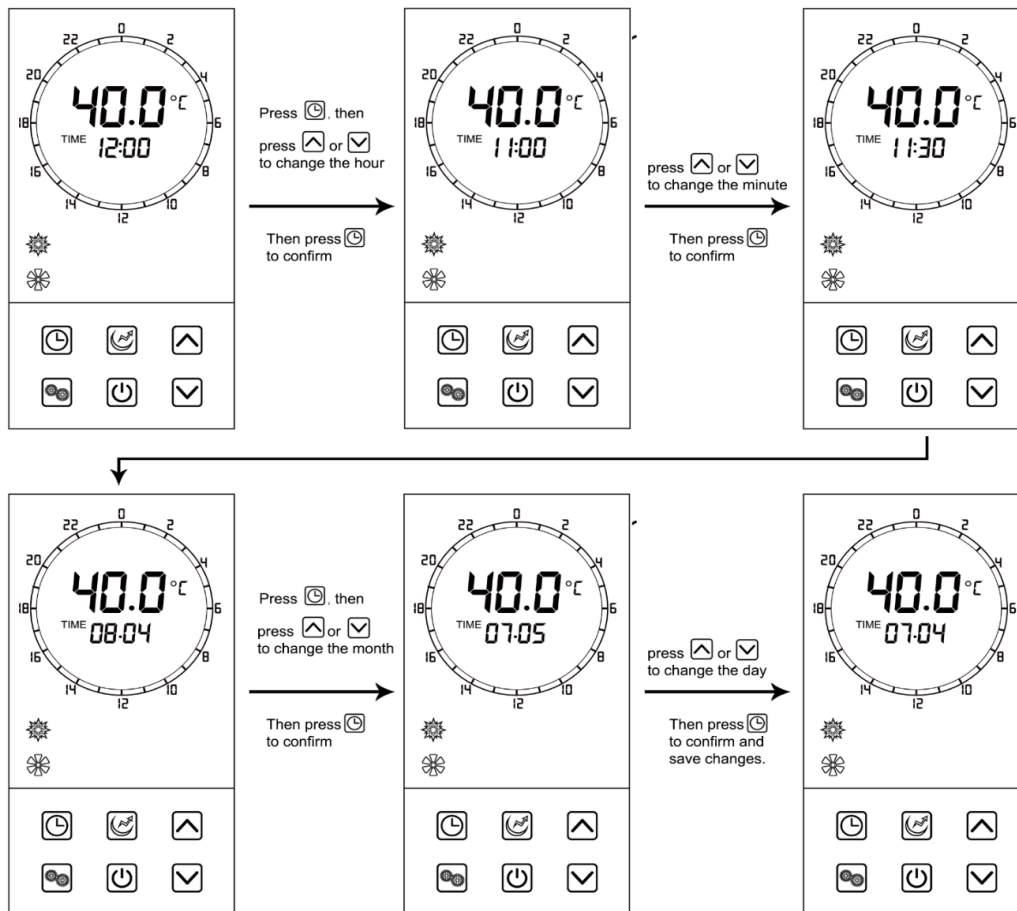

6.2.8 Setting & Cancelling Timers

Timers can be set in standard mode, economic mode, auto mode & fast heating mode. They can be set by using buttons or using the touch timing circle. The unit will run during the lit time periods and stop in the dim areas.

Touch Method	Button Method
<ul style="list-style-type: none"> Press and hold for 2 seconds (the timer display will flash) When the timer display flashes, choose your start-up time (A) and end time (B). Press to save the setting and exit back to the main interface. 	<ul style="list-style-type: none"> Press and hold for 2 seconds (the timer display will flash) When the timer display flashes, choose the start-up time (C) and end time (D) by pressing or and . Press to save the setting and exit back to the main interface.

Example: Setting the unit to run from 7-11am & 4pm-6pm using Touch mode.

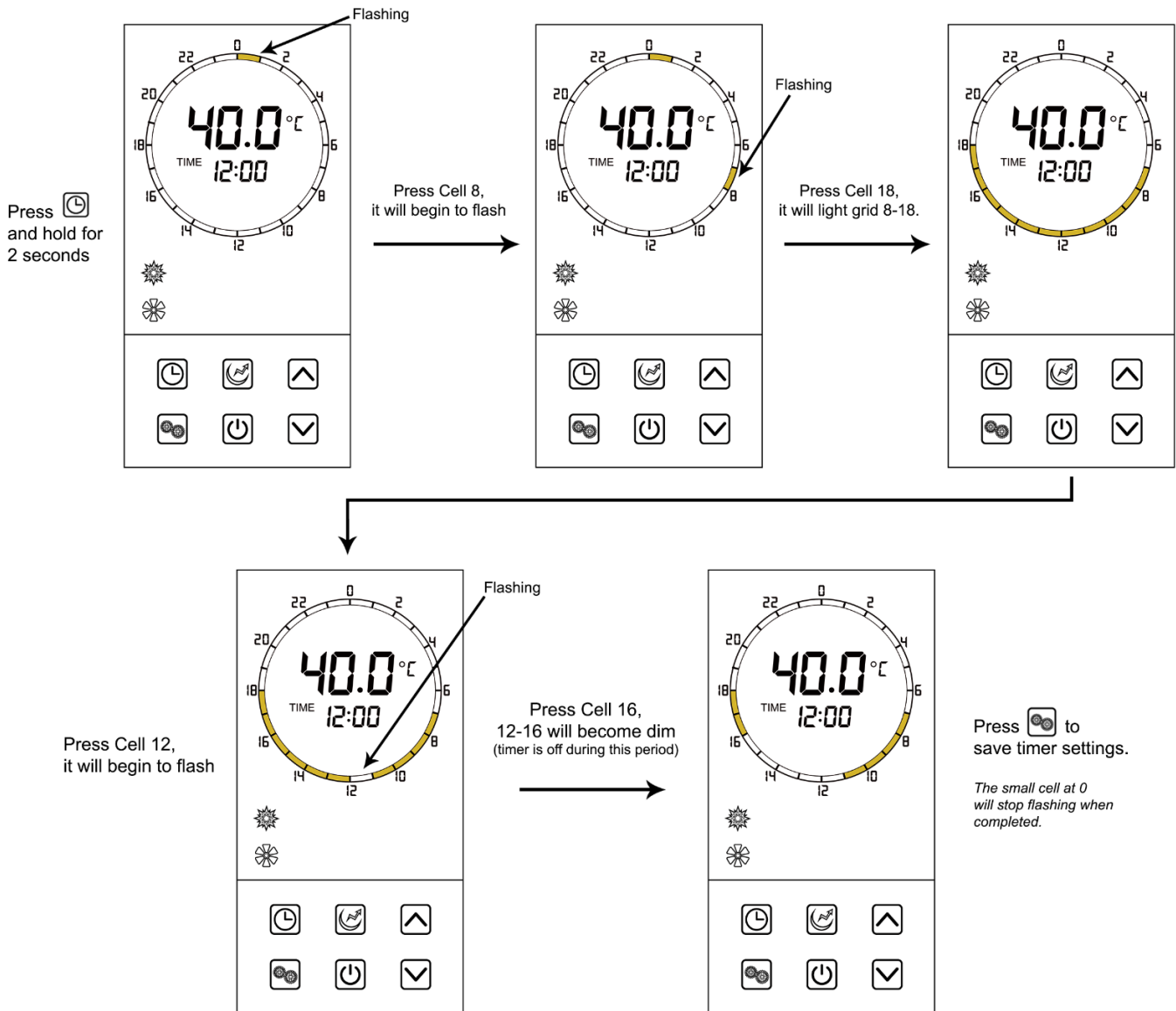

To **cancel** a timer once it has been set, hold down the CLOCK button for 2 seconds until the timer display begins flashing (as you would set the timer).

Press the POWER button while the timer is flashing to cancel it. The yellow timing periods will disappear when the timer has been cancelled.

6.2.9 Vacation Mode



Vacation Mode allows you to turn the unit off to conserve power for an extended period of time, and restart operation on a date you specify. This ensures you have hot water waiting for you upon your return.

Ensure the unit is 'OFF' before setting vacation mode. The date you set in this mode will determine what date the unit starts back up.

After selecting vacation mode, press and hold for 2 seconds, the 'month' value will begin to flash in the display area. Press the **UP** or **DOWN** arrows to display the desired month, then press to confirm and move to altering the 'day' value.

The 'day' value will flash when it is selected, use the arrow keys to select your desired start day, then press to save all changes and exit back to the main interface.

Note: Format is mm/dd
Example: The unit will start up on September the 28th.

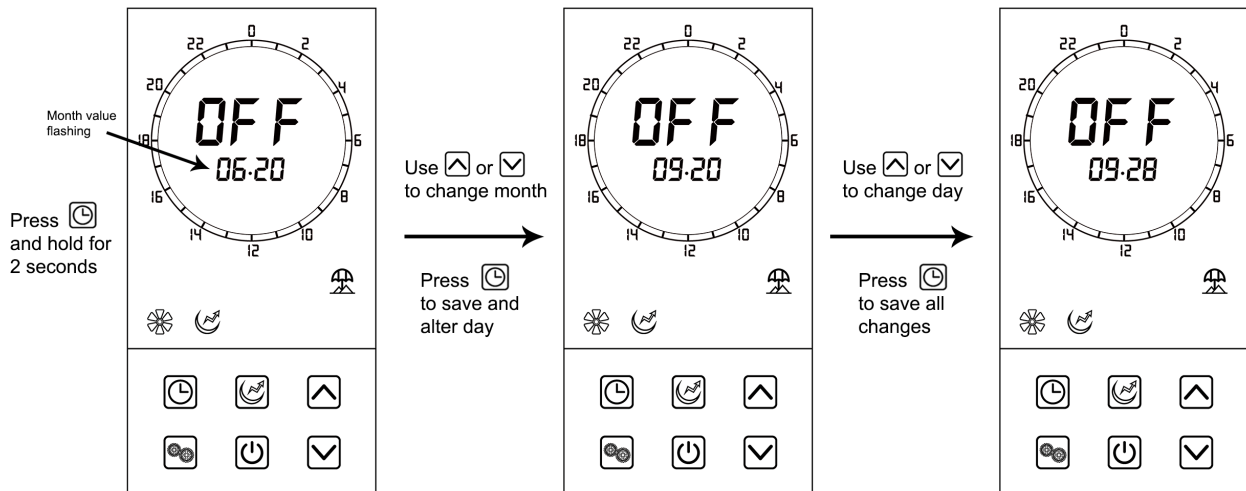

6.2.10 Sanitech System

The Sanitech feature's purpose is to keep the water free of bacteria such as Legionella by heating the tank water to 60°C each day at midday.



An instance when you may want to alter the Sanitech function is if you have solar power and would prefer the Sanitech to run during the day, for example, at a specific time to maximise solar energy use.

If you would like to change this function, **contact EvoHeat's service department** for guidance. Incorrectly attempting to adjust these settings yourself could significantly disrupt the unit's operation.

6.2.11 Fan/Ventilation Function



This function may come in useful if the system is installed inside and the fan settings need to be adjusted to suit ducting or external ventilation. This function allows you to set the fan speed as Off, Low Speed or High Speed.

If you would like to change this function, **contact EvoHeat's service department for guidance.** Incorrectly attempting to adjust these settings yourself could significantly disrupt the unit's operation.

7. Troubleshooting

7.1 Troubleshooting Q & A

Why does the compressor not run immediately when I start up the unit?

- After the unit is powered on, following a shutdown, there is a built-in delay of 3 minutes before the compressor starts running. This delay is a self-protection feature of the unit, designed to prevent damage and ensure the system's longevity.

Why does the outlet water temperature on the display sometimes increase slowly?

- Initially, there is a variation in water temperature between the upper and lower layers of the tank. As the heating process begins, the temperature in different parts of the tank equalizes, which initially causes a slower rise in temperature. Once the temperature becomes more uniform throughout the tank, the increase on the display will be faster.

Why does the outlet water temperature on the display decrease when the unit is in heating mode?

- If there is a significant temperature difference between the upper (hotter) water and the bottom (colder) water in the tank, the water temperature may decrease slightly due to convection currents. These currents occur as hot water rises and cold water sinks, leading to a temporary mixing and a slight decrease in temperature.

Why does the unit not start heating immediately when the outlet water temperature decreases?

- The unit is designed to avoid frequent on/off cycling, which can occur due to minor temperature fluctuations. If the hot water in the tank is not used for an extended period, the temperature may naturally decrease due to heat loss. To prevent unnecessary cycling, the unit is programmed not to start heating again until the water temperature decreases by more than 5 degrees. This feature helps in conserving energy and extending the life of the unit.

Why does the outlet water temperature decrease abruptly?

- The decrease in outlet water temperature occurs due to the mixing of hot and cold water within the tank. When the hot water at the top of the tank is depleted, cold water from the bottom can reach the upper sensor, resulting in a sudden temperature drop.

Why is hot water still available when the display shows a significant decrease in the outlet water temperature?

- This happens because the upper sensor is located near the top of the tank. Even when the display indicates a significant decrease in outlet water temperature, approximately one-fifth of the tank's capacity for hot water remains available.

Why does the compressor stop while the fan continues to run in heating mode?

- In heating mode, the unit may need to defrost if the evaporator freezes due to low ambient temperatures. During this defrosting process, the compressor will stop operating, but the fan will continue to run to facilitate defrosting.

Why does the heating process take the time it does?

- The unit is engineered for optimal energy efficiency, which means it operates with lower power consumption and thus, a standard heating duration that aligns with typical heat pump performance. The usual heating time ranges between 2 to 6 hours, depending on factors such as the initial temperature of the water, the volume of water usage, and the surrounding environmental temperature. This duration is standard for heat pumps and reflects the balance between energy efficiency and effective heating performance.

7.2 Error Codes

Error	Reason	Elimination Methods
P01	Bottom Water Temperature Sensor Failure (open or short circuit)	Inspect or replace the bottom water temperature sensor.
P02	Top Tank Water Temperature Sensor Failure (open or short circuit)	Inspect or replace the top tank water temperature sensor.
P03	Discharge Temperature Sensor Failure (open or short circuit)	Inspect or replace the discharge temperature sensor.
P04	Ambient Temperature Sensor Failure (open or short circuit)	Inspect or replace the ambient temperature sensor.
P05	Coil Temperature Sensor Failure (open or short circuit)	Inspect or replace the coil temperature sensor.
P07	Suction Temperature Sensor Failure (open or short circuit)	Inspect or replace the suction temperature sensor.
P08	Solar Temperature Sensor Failure (open or short circuit)	Inspect or replace the solar temperature sensor.
P82	Discharge Overheating Protection	Check for leaks or blockages in the refrigerant system.
E01	High Pressure Protection (Excessive exhaust pressure, high pressure switch activated)	Inspect the high-pressure switch and check for blockages in the refrigerant system.
E02	Low Pressure Protection (Reduced suction pressure, low pressure switch activated)	Inspect the low-pressure switch and check for leaks in the refrigerant system.
E08	Communication Failure (Issue with wired remote control signal)	Check the connection between the wired remote control and the motherboard.
E09	Winter Frost Protection	The water temperature is too low - ensure anti-freezing measures are in place.
E11	DC Motor Stalling	Inspect the motor and its connection.
E13	Electronic Anode 1 Short-Circuit	Check the electronic anode and its connection to the main controller.
E14	Electronic Anode 1 Open-Circuit	Check the electronic anode and its connection to the main controller.
E18	Electronic Anode 2 Short-Circuit	Check the electronic anode and its connection to the main controller.
E19	Electronic Anode 2 Open-Circuit	Check the electronic anode and its connection to the main controller.
E43	High Pressure Switch Triggered Thrice	Inspect the high pressure switch and check for blockages in the refrigerant system.
E44	Low Pressure Switch Triggered Thrice	Inspect the low pressure switch and check for leaks in the refrigerant system.
E45	Discharge Overheating Triggered Thrice	Check for leaks or blockages in the refrigerant system.

8. Appendix

8.1 Wiring Diagram

- AT: Ambient temperature
- BTT: Bottom of tank temperature
- COMP: Compressor
- CT: Coil temperature
- E2V: Electromagnetic 2 way valve
- EEV: Electronic expand valve
- ET: Exhaust temperature
- FM: Fan motor
- HP: High pressure protection
- HT: Electrical Heater
- MTS: Mechanism temperature switch
- SUT: Suction temperature
- TC: Transformer
- TTT: Top of tank temperature

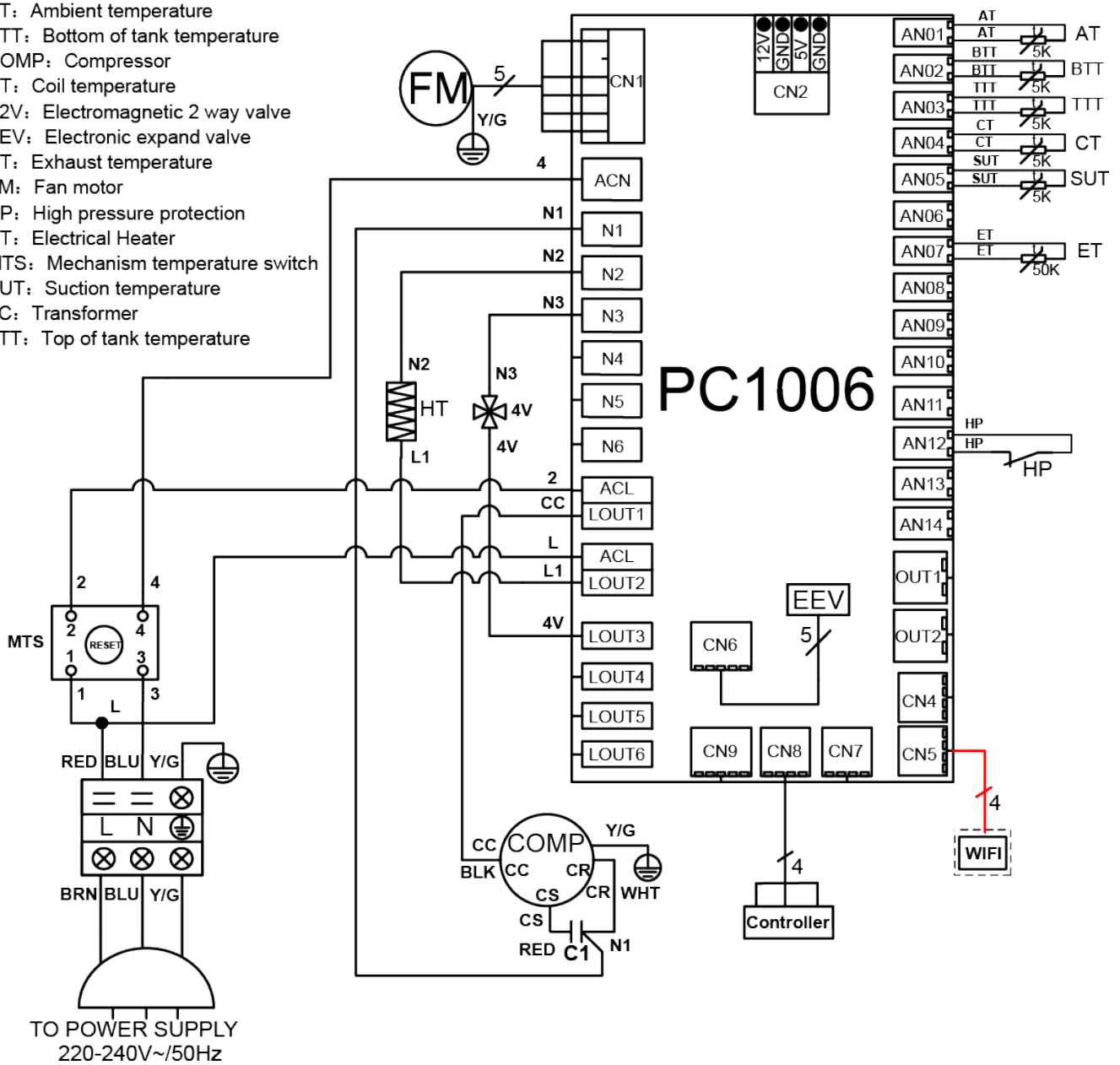

8.2 Use of the P&T Valve



WARNING: Failing to operate the relief valve easing gear at least once every six months may result in the water heater exploding. Continuous leakage of water from the valve may indicate a problem with the water heater.



The Pressure and Temperature (P&T) valve is crucial for maintaining safe levels inside the tank. It automatically opens to release water if either the temperature or pressure exceeds the predetermined settings, preventing dangerous build-ups.

Maintenance of Safety Valve: Test the safety valve handle every six months to clear out calcium carbonate deposits and ensure the valve is unblocked. Be cautious of the high temperature of the discharged water to avoid burns. Additionally, keep vent pipes thermally insulated to prevent them from freezing in winter, which can pose safety risks.

Valve Replacement: If replacement of the P&T valve is necessary, it should match the original in performance, size, and specifications.

8.3 Using the Overheating Protector

The overheating protector is designed to turn off the power during emergencies or power issues, ensuring the water doesn't overheat.

In the event of a thermal cut-out, consider it a potential safety hazard. It's crucial to have the unit serviced by a qualified technician before attempting a reset. Contact EvoHeat for service in such cases.

To return the unit to its normal operation status by resetting manually:

- a) To access the overheat protector, remove the front dark grey controller panel.
- b) Remove the 3 screws on the front panel and push the front cover upwards.
- c) Remove the remaining screws which cover the overheat protector panel.

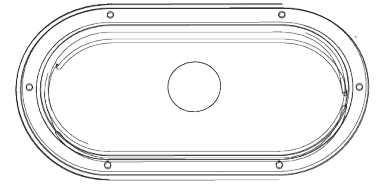

Remove the screws and open the cover

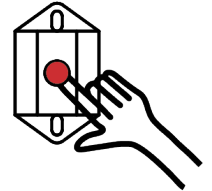

Press the red button to reset

8.4 Draining the Water Tank



The water from the hot water tap and the drain plug will be hot. Be careful of burns and scalds. Wear protective clothing.

1. Close the cold-water inlet valve into the EVO270-E.
2. Open a hot water tap inside the premises.
3. Undo the drain plug on the base of the unit to drain the water from the system.

8.5 Wi-Fi Module Connection (Optional)

Note: If you do not have a Wi-Fi module to install, apply heat shrink to the plug, this will protect it from water ingress.

The optional Wi-fi Control upgrade can be purchased to allow you to remotely control your EvoHeat hot water heat pump from your phone.

Newly installed units will have a small cable protruding from behind the top panel covered in heat shrink.

If you are installing the Wi-Fi module, simply connect the cable of the Wi-Fi module to the one that protrudes.

Once the Wi-Fi module has been connected, ensure that the connection plug has the heat shrink applied to the plug and the cable is protected from water and dust.

The module must be placed with the cord facing downwards to protect it from water tracking.

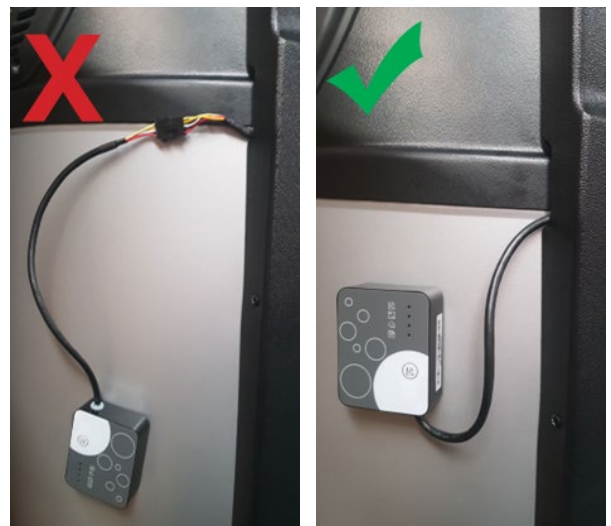

9. Maintenance

9.1 Maintenance Periods

Your EVO270-E will operate most efficiently if regularly inspected as part of your home maintenance schedule.

ANNUAL MAINTENANCE

It is recommended that the minor maintenance be performed every 12 months by the dwelling occupant.

The minor maintenance includes:

- Operate the easing lever on the temperature pressure relief valve. It is very important you raise and lower the lever gently. Exercise care to avoid any splashing of water, as water discharged from the drain line will be hot. Stand clear of the drain lines point of discharge when operating the valve's lever.
- Operate the easing level on the expansion control valve (if fitted). It is very important you raise and lower the lever gently.
- Conduct a visual inspection of all plumbing and electrical connections.
- Check the condensate drain line to ensure it is not blocked.
- Check that air vents and evaporator is not blocked or obstructed, and if necessary, isolate the power to the system and clear with a brush.
- Conduct a general external clean of the unit with a damp cloth.

THREE-YEAR SERVICE



It is a warranty requirement that a three (3) year service must be conducted on the EVO270-E.

Just as a car needs regular servicing, your heat pump also requires a three-year service to maintain efficiency and ensure long-term performance.



Warning: Servicing of a water heater must only be carried out by qualified EvoHeat personnel. Phone EvoHeat Service on 1300 859 933 for our closest Accredited Service Agent.

Note: The three-year service and routine replacement of any components such as the anode and relief valve(s) are not included in the EvoHeat warranty. Only genuine replacement parts should be used on this water heater.

The service includes the following actions:

- Replace the temperature limiting valve.
- Replace the temperature pressure relief valve.
- Inspect the anode and if required, replace the anode. If the anode is not replaced, it should be replaced within three years of this service.
- Check the heating cycle of the unit.
- Visually check the unit for any potential problems.
- Inspect the plumbing and electrical all connections.
- Check the condensate on drain line to ensure it is not blocked.

Note: The water heater may need to be drained during this service. After the completion of the service, the water heater will take some time to reheat the water. Depending upon the power supply connect on, hot water may not be available until the next day.



10. Warranty



Refer to the EvoHeat website for warranty details

<https://evoheat.com.au/warranty-terms/>

REGISTER YOUR WARRANTY



EvoHeat highly recommend customers complete their warranty details online to ensure efficient warranty claim processing. To register your warranty, scan our QR Code or head to our website and fill in the Warranty Registration Form: <https://evoheat.com.au/warranty-registration/>

1. Warranty terms are from date of purchase.
2. This warranty excludes any defect or injury caused by or resulting from misuse, abuse, neglect, accidental damage, improper voltage, vermin infestation, incompetent installation, any fault not attributable to faulty manufacture or parts, any modifications which affect the reliability or performance of the unit.
3. This warranty does not cover the following:
 - a) Natural Disasters (hail, lightening, flood, fire etc.)
 - b) Damage resulting from any animal or creature (including vermin, reptiles and insects)
 - c) Rust or damage to exterior coatings, materials, and cabinet caused by corrosive atmosphere or weather/environmental conditions.
 - d) When serviced by an unauthorised person without the permission of Evo Industries.
 - e) When a unit is installed by an unqualified person.
 - f) When failure occurs due to improper or incorrect installation.
 - g) Where failure occurs due to failure of any other equipment connected in relation with the EvoHeat unit (e.g. power supply, water pump etc.).
 - h) Where failure occurs due to improper maintenance or misuse (refer Operating Instructions).
 - i) Where the unit has not had its three-year general maintenance service performed by a certified plumber. Proof of this service will be required for warranty claims beyond three years.
 - j) 'No Fault Found' service calls where the perceived problem is explained within the operation instructions.
 - k) Costs associated with delivery, handling, freighting, or damage to the product in transit.
 - l) Where the unit has been relocated from its originally installed location.
4. If warranty service is required, you should:
 - a) Contact Evo Industries Australia on 1300 859 933 or via our Contact page on our website.
 - b) Provide a copy of your receipt as proof of purchase.
 - c) Have completed the online Service Request Form via the website www.evoheat.com.au/service-request/
5. Onsite technical service is available within the normal operating area of your Evo Authorised Service Agents. Service outside this area will incur a traveling fee.
6. Our goods come with guarantees that cannot be excluded under the Australian Consumer Law. You are entitled to a replacement or refund for a major failure and compensation for any other reasonably foreseeable loss or damage. You are also entitled to have the goods repaired or replaced if the goods fail to be of acceptable quality and the failure does not amount to a major failure.